

Data sheet

Part number : VMPN1108MS-TR



2011/65/EU, (EU)2015/863
10 Substances regulation compliant



Lead-free solder heat resistant product

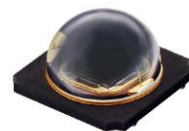

Package	<p>Low red glow</p> <p>Wide distribution angle with dome lens</p> <p>IRED Peak wavelength : 955nm</p> <p>Outer dimension 3.8 x 3.8 x 2.1mm(L x W x H)</p>
Product features	<ul style="list-style-type: none"> • Radiant intensity : 480mW/sr (TYP.) @ $I_F = 1A$ • AEC-Q102 compliant • Operating temperature : -40 to +125 deg. • Lead-free soldering compatible • RoHS: 2011/65/EU, (EU)2015/863 compliant

This product is classified “Exempt” according to “Photobiological safety of lamps and lamp systems: IEC62471”. (Calculated at radiant intensity 480 mW/sr, @ $I_F = 1A$)

Recommended applications

- Automotive use : Advanced Driver Assistance System : driver monitoring system, occupant monitoring system, gesture control, etc.
- Light source for surveillance camera
- Other use (TOF (Time Of Flight) sensor, Security equipment) etc.

Outline dimensions

VMPN1108MS-TR

Unit : mm
 Weight : 26mg
 Tolerance : ±0.1

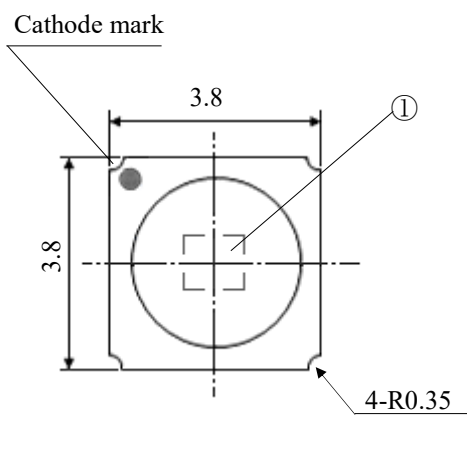

Top view

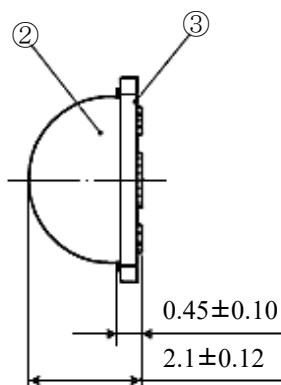

Side view

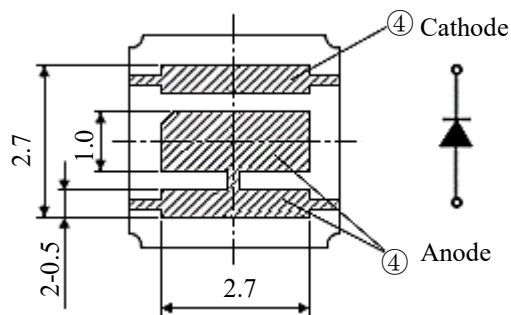

Bottom view

No.	Part name	Materials	Qty.
①	LED die	AlGaAs	1
②	Encapsulant	Silicone resin	-
③	Substrate	Glass fabrics	1
④	Terminal	Au plating	Anode : 2 Cathode : 1

Recommended pad

Unit : mm
 Tolerance : ±0.1

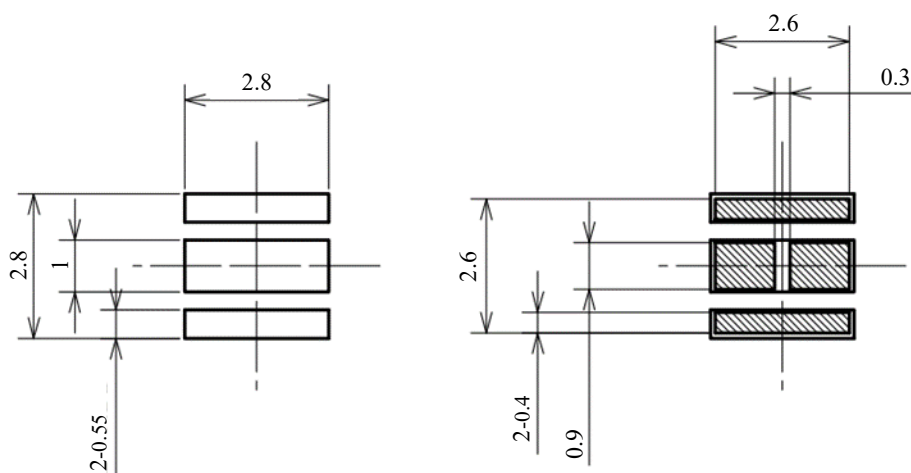

Foot print

Solder stencil (t=0.15mm)

Specifications

VMPN1108MS-TR

【 Absolute maximum ratings 】

Item	Symbol	Maximum ratings	Units	
Operating temperature	T_{opr}	-40 to +125	°C	Note 1
Storage temperature	T_{stg}	-40 to +125	°C	Note 1
Junction temperature	T_j	145	°C	
Forward current	I_F	1.0	A	
Pulse forward current($t_w \leq 100\mu\text{sec}$, $\text{duty} \leq 1\%$)	I_{FRM}	5.0	A	
Reverse voltage	V_R	5.0	V	
Electrostatic discharge threshold "HBM" ($T_a=25^\circ\text{C}$)	V_{ESD}	2.0	kV	Note 2
Peak temperature of reflow soldering	T_{sld}	260	°C	

Note 1 The ranges of operating and storage temperature are not applied to taping condition.

Note 2 ESD testing method : Human Body Model(HBM) /Acc. to ANSI/ESDA/JEDEC JS-001

【 Thermal characteristics 】

(Ta=25°C)

Item	Symbol	Typ.	Max.	Units
Thermal resistance(Junction - soldering Point)	$R_{th(j-s)}$	5.0	7.0	°C/W

Specifications

VMPN1108MS-TR

【 Electro-optical characteristics 】

(Ta=25°C)

Item	Symbol	Conditions	Min.	Typ.	Max.	Units	
Radiant intensity	I_e	$I_F = 1A$	330	480	650	mW/sr	Note 3,4
Total radiant flux	ϕ_e	$I_F = 1A$	-	1,630	-	mW	Note 4
Peak wavelength	λ_p	$I_F = 1A$	940	955	965	nm	Note 4,6
Spectral bandwidth at 50% of I_{max}	$\Delta\lambda$	$I_F = 1A$	-	37	-	nm	
Half intensity angle	$2\theta_{1/2}$	-	-	120	-	deg.	
Forward voltage	V_F	$I_F = 1A$	2.4	2.9	3.2	V	Note 5
Reverse current	I_R	$V_R = 5V$	-	-	5	μA	Note 5
Terminal capacitance	C_t	$V = 0V$ $f = 1MHz$	-	100	-	pF	

Note 3 This product is classified "exempt" according to "Photobiological safety of lamps and lamp systems: IEC62471".

Note 4 Measurement time : Lighting at moment, Integration time 30msec

Note 5 Measurement time : Lighting at moment, Application time 110msec

Note 6 Measurement tolerance: $\pm 1nm$

【 Sorting chart for radiant intensity 】

LEDs shall be sorted out "Radiant intensity" into the following chart and each rank parts shall be packed separately when shipping.

Rank	Radiant intensity(mW/sr)		Conditions
	Min.	Max.	
A	330	450	$I_F=1A$ $T_a=25^\circ C$
B	450	650	

Notes

Measurement tolerance: $\pm 7\%$

Measurement time : Lighting at moment, Integration time 30msec

【 Sorting chart for forward voltage 】

LEDs shall be sorted out "Forward voltage" into the following chart and each rank parts shall be packed separately when shipping.

Rank	Forward voltage (V)		Conditions
	Min.	Max.	
A	2.4	2.7	$I_F = 1A$ $T_a = 25^\circ C$
B	2.7	3.2	

Notes Measurement tolerance: $\pm 0.1V$

Measurement time : Light at moment 110msec

Technical data

VMPN1108MS-TR

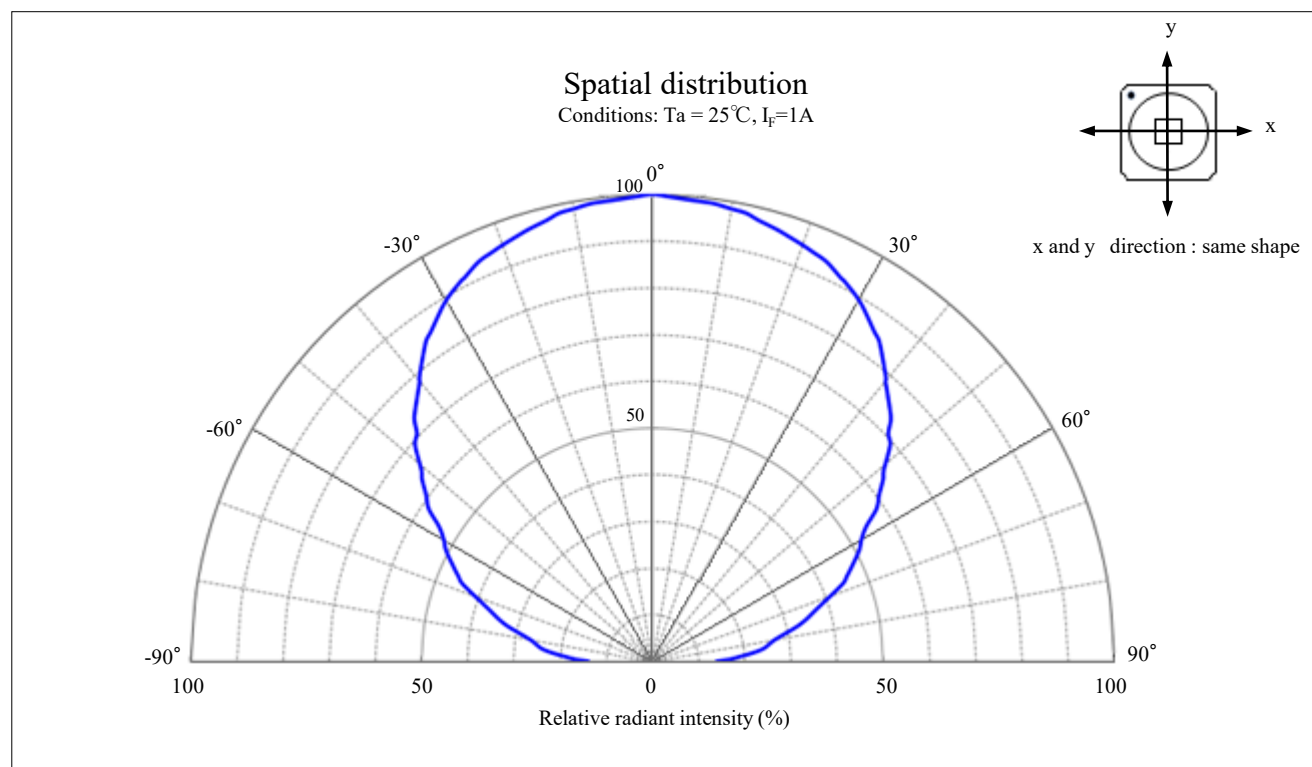
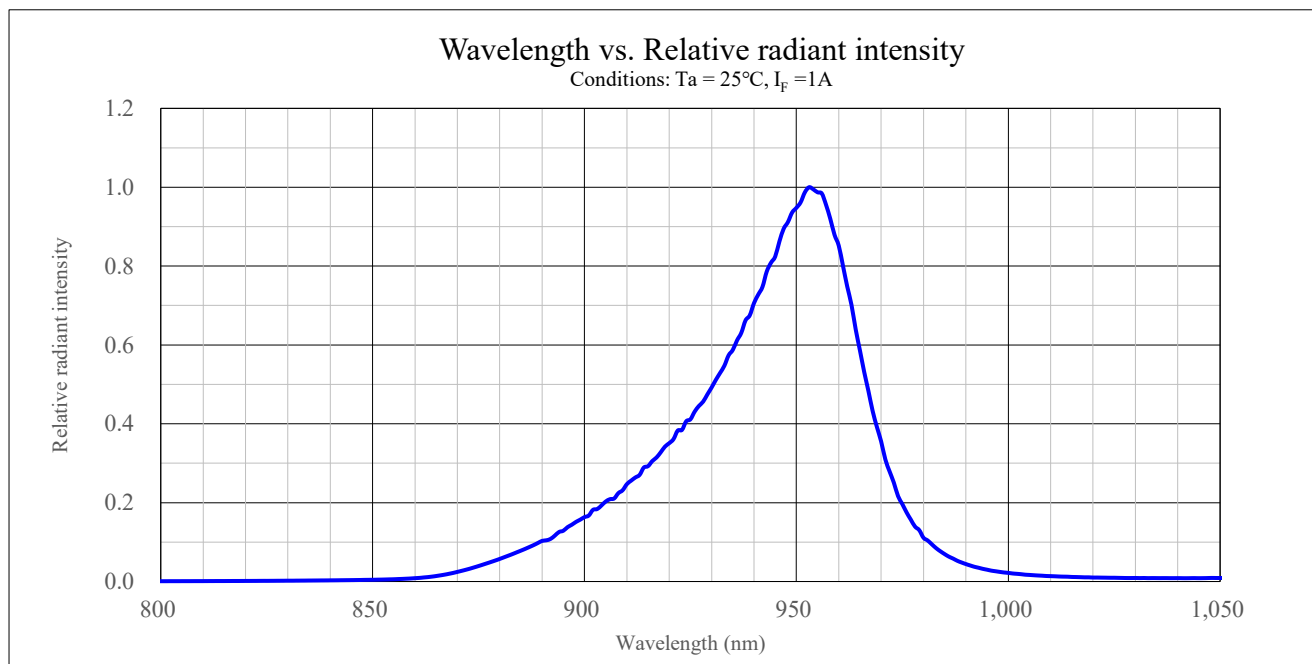

Technical data

VMPN1108MS-TR

Forward current vs. Relative total radiant flux

Condition : $T_a = 25^\circ\text{C}$, Single pulse ($t_w = 100\mu\text{s}$)

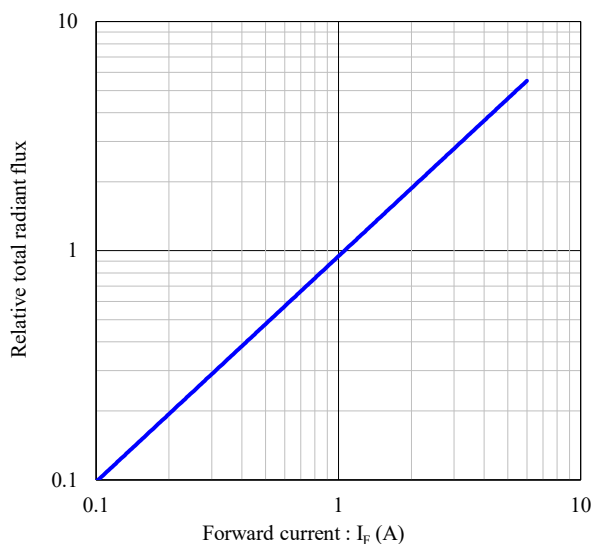

Junction temp. vs. Relative total radiant flux

Condition : $I_F = 1\text{A}$

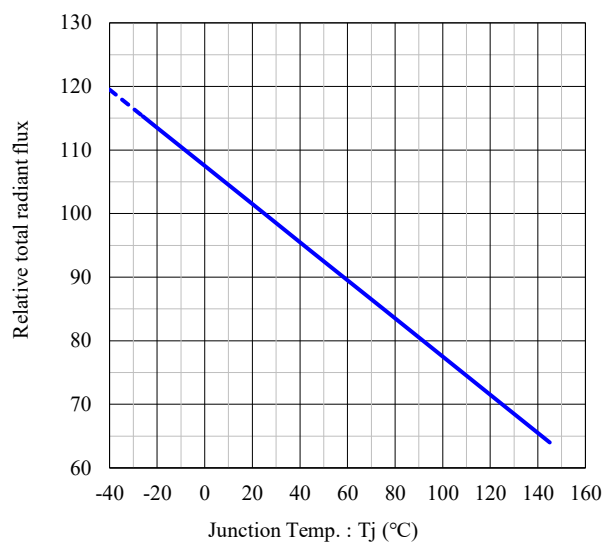

Forward voltage vs. Forward current

Condition : $T_a = 25^\circ\text{C}$, Single pulse ($t_w = 100\mu\text{s}$)

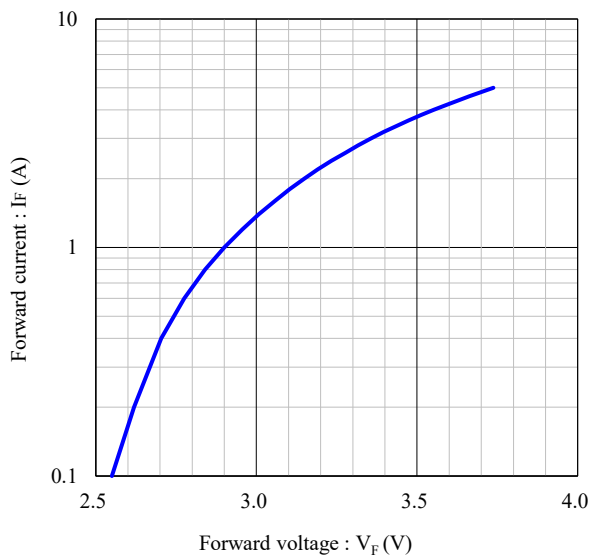

Junction temp. vs. Forward voltage

Condition : $I_F = 1\text{A}$

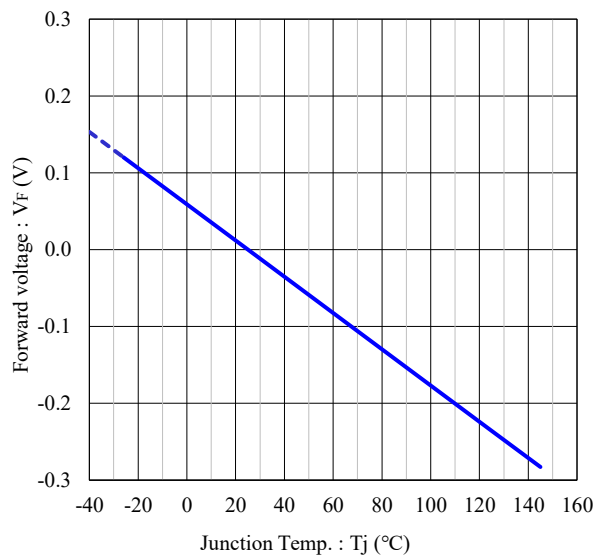

Technical data

VMPN1108MS-TR

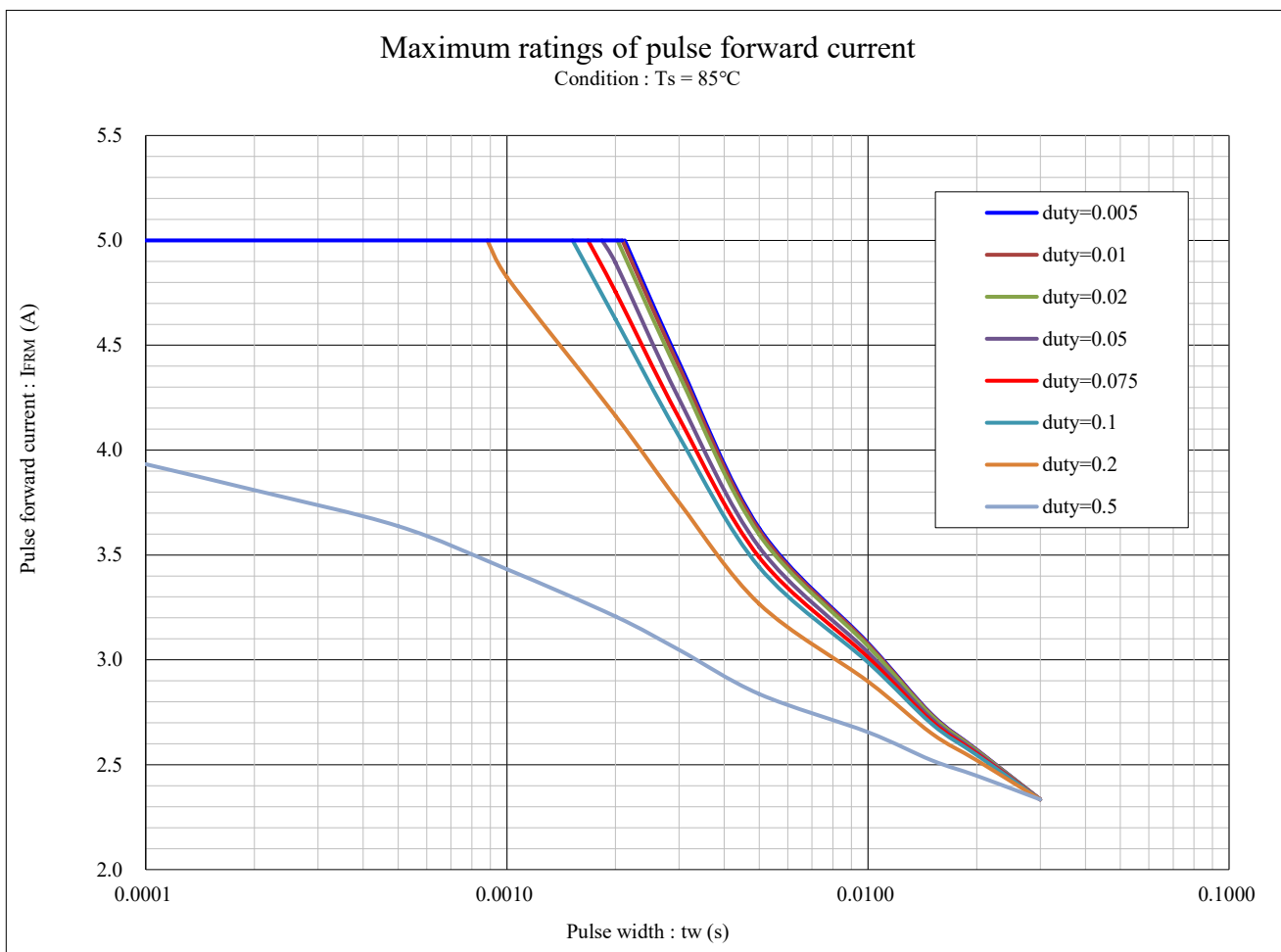
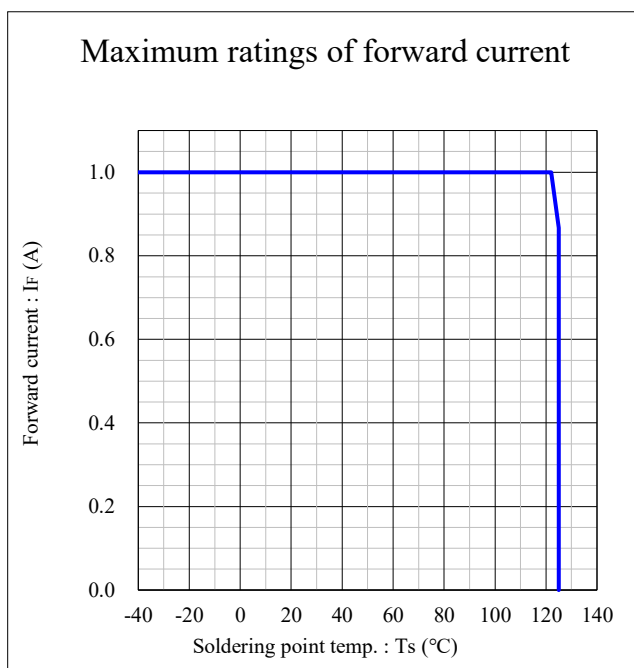
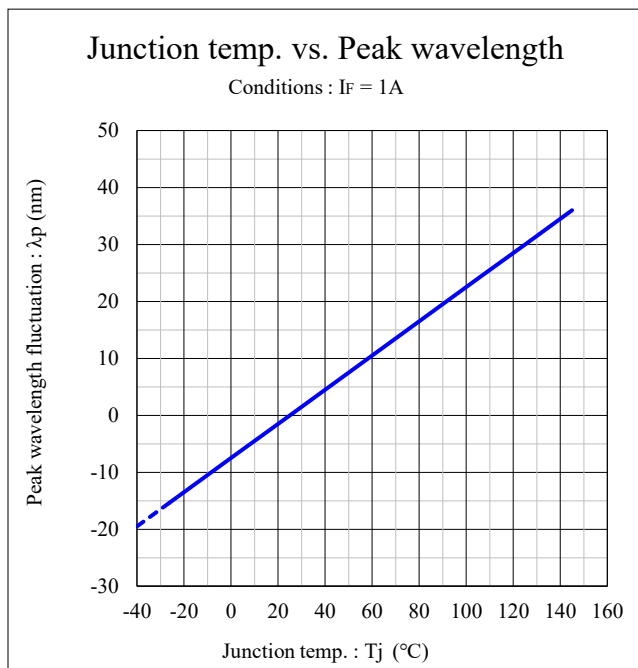

Soldering condition

VMPN1108MS-TR

【Soldering Precaution】

- Heat stress during soldering will influence the reliability of LEDs, however that effect will vary on heating method. Also, if components of varying shape are soldered together, it is recommended to set the soldering pad temperature according to the component most vulnerable to heat (e.g., surface mount LED).
- The LEDs constituent parts, including the resin, do not stabilize immediately after soldering. Any mechanical stress may cause damage to the products. Please avoid stacking the PCBs, or any other storage method which may cause the PCBs to bend; also, prevent contact of LED with any materials.
- Recommended temperature profile for the Reflow soldering is listed as the temperature of the resin surface. Temperature distribution varies on heating method, PCB material, other components in the assembly, and mounting density.
Typically, when FR-4 PCB is mounted with one LED and heated via far infrared and hot air, the difference in temperature between PCB and LED resin will be around 5 to 10°C.
Please do not repeat the heating process in Reflow process more than two times.

This product is equivalent to MSL 2a according to IPC/JEDEC J-STD-020F.

【Recommended reflow soldering condition】

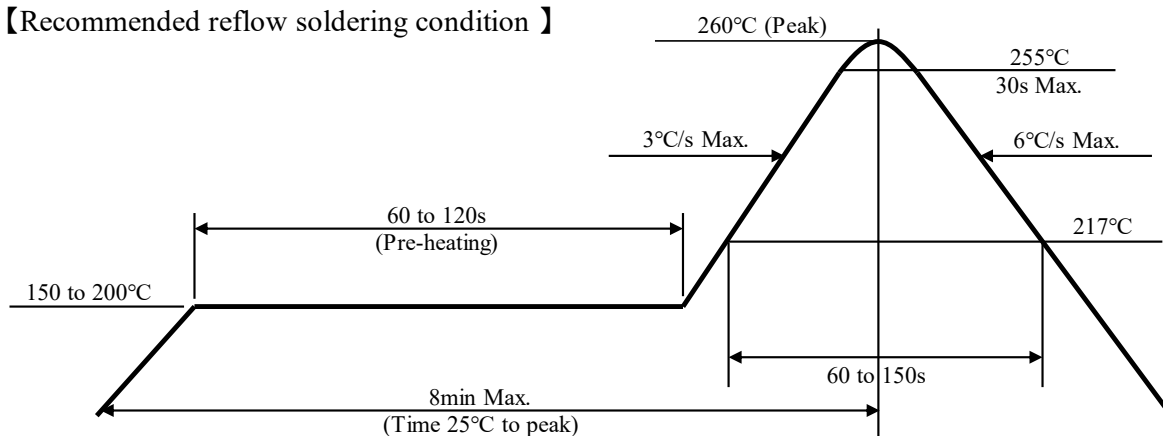

- Note 1 Temperature Profile for the reflow should be set to the surface temperature of resin which is on the top of LED. This should be the maximum temperature for soldering. Lowering the heating temperature and decreasing heating time is very effective in achieving higher reliability.
- Note 2 The reflow soldering process should be done up to twice (2 times Max). When second process is performed, interval between first and second process should be as short as possible to prevent absorption of moisture to resin of LED. The second soldering process should not be done until LEDs have returned to room temperature (by nature-cooling) after first soldering process.

Soldering condition

VMPN1108MS-TR

4. When using a metal PCB, the solder may crack and problems may occur due to major stress on the soldered portion caused by thermal shock. Please carry out a thorough advance verification before use. For the metal PCB's insulation, it is recommended to use stress-reducing materials.
5. Manual soldering and flow soldering (dip soldering) are not recommended for this product.
6. Isopropyl alcohol is recommended for cleaning. Some chemicals, including Freon substitute detergent could corrode the lens or the casing surface, which cause discoloration, cloud, crack and so on. Please review the reference chart below for cleaning. If water is used to clean (including the final cleaning process), please use pure water (not tap water), and completely dry the component. Cleaning with ultrasonic is not recommended.

Cleaning agents	Recommended / Not recommended
Ethyl alcohol	✓ Recommended
Isopropyl alcohol	✓ Recommended
Pure water	✓ Recommended
Trichloroethylene	x Not recommended
Chloroethene	x Not recommended
Acetone	x Not recommended
Thinner	x Not recommended
Hexane	x Not recommended

Handling precaution

VMPN1108MS-TR

【For Electric Static Discharge (ESD)】

This type of LED lamp is highly sensitive to surge voltage generated by the On/Off status change and discharges of static electricity through frictions with synthetic materials, which may cause severe damage to the die or undermine its reliability. Damaged products may experience conditions such as extremely high reverse voltage, or a decrease of forward rise voltage, deteriorating its optical characteristic. Stanley products are packed with anti-static components. However, the following precautions and measures are vital in ensuring product quality during shipment.

1. Electrification/Static electricity protection

Stanley recommends the following precautions in order to avoid product (die) damage from static electricity, when an operator and other materials electrified by friction coming in contact with the product.

- ① Do not place electrified non-conductive materials near the LED product.
Avoid LED products from coming into contact with metallic materials.(Should the metallic material be electrified, the sudden surge voltage will most likely damage the product.)
- ② Avoid a working process which may cause the LED product to rub against other materials.
- ③ Install ground wires for any equipment, where they can be installed, with measures to avoid static electricity surges.
- ④ Prepare a ESD protective area by placing a Conductive Mattress (1MΩ MAX.) and Ionizer to remove any static electricity.
- ⑤ Operators should wear a protective wrist-strap.
- ⑥ Operators should wear conductive work-clothes and shoes.
- ⑦ To handle the products directly, Stanley recommends the use of ceramic, and not metallic, tweezers.

2. Working environment

- ① A dry environment is more likely to cause static electricity. Although a dry environment is ideal for storage state of LED products, Stanley recommends an environment with approximately 50% humidity after the soldering process.
- ② Recommended static electricity level in the working environment is 150V, which is the same value as Integrated Circuits (which are sensitive to static electricity).

Handling precaution

VMPN1108MS-TR

【Other precautions】

1. The products are designed to achieve higher performance reliability, however, they can be influenced by usage conditions.
2. Absolute maximum ratings are set to prevent LED products from failing due to excess stress (temperature, current, voltage, etc.). These ratings must never be overrun even for a moment.
3. To achieve the highest performance reliability, it is necessary to take into account, factors such as forward voltage adjusted to the usage temperature condition, derating of the power consumption, and other variable factors.
4. Please insert Straight Protective Resistors into the circuit in order to stabilize LED operation and to prevent the device from igniting due to excess current.
5. Please avoid to using the products with materials and products that contain sulfur and chlorine elements because the reliability may be decreased. Please keep in desiccator before and after mounting, to prevent the products from being affected by corrosive gas.
Also please make sure there isn't any gas in the surrounding area or entering from outside when using the products.
6. Please avoid to stick foreign material because molding resin in the products has adhesiveness.
And please don't touch lens portion.
7. Supersonic wave welding is not recommended because wire open circuit may occur.
ex) bonding outer lens to this product or housing
8. Please check the actual performance in the assembly because the Specification Sheets are described for LED device only.
9. When there is a process of supersonic wave welding etc. after mounting the product, there is a possibility of affecting on the reliability of junction part in package (junction part of die bonding and wire bonding). Please make sure there is no problem before using.
10. The products are designed to perform without failure in the recommended usage conditions. However, please take the necessary precautions to prevent fire, injury, and other damage from these unexpected failures.
11. The products are manufactured to be used for ordinary electronic equipment.
Please contact our sales staff in advance when exceptional quality and reliability are required, when the failure or malfunction of the products might directly jeopardize life or health (such as for airplanes, aerospace, medical applications, nuclear reactor control systems and so on).

Handling precaution

【Other precautions】

12. Please avoid overload to the product when using tweezers to pick up LEDs.
Overload might cause deformation, disconnection, chip-outs and consequently lead to lighting failure.
Tweezers with flat tips is recommended, please avoid using tweezers with sharp tips.

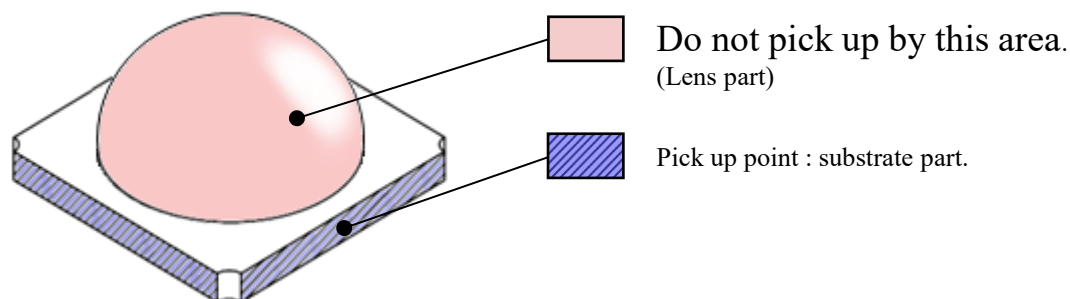

13. Low hardness resin is used for lens. Please avoid overload to the surface of lens which might cause chip-outs, encapsulant delamination, and deformation, nicks, wire disconnection and decreasing reliability.
Be careful when dealing with the products and pay attention to following points.

- During mounting process, keep lens from coming in contact with absorbing nozzle and refer to precautions on next page.
- Pay attention to handling and storage of LEDs even after mounting, because overload caused by stacking PCBs and shock due to dropping and crashing might also lead to deformation, disconnection, and chip-outs.
- In the processes of water pressure during cleaning, air pressure, drying and other processes after mounting, overload to lenses should be avoided.

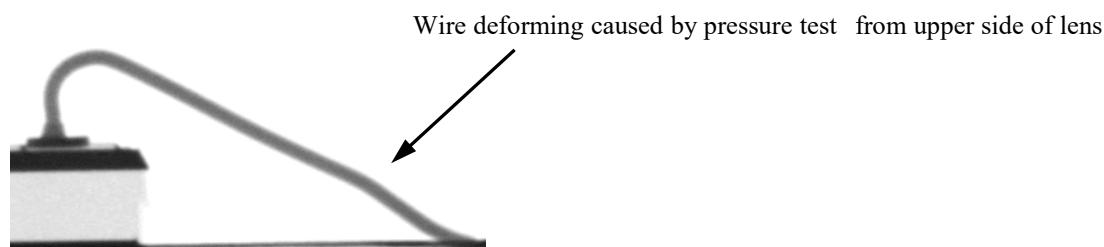

14. The formal specification sheets should be exchanged and signed by both parties.

Handling precaution

【 Handling Precautions for Product Mounting 】

<Recommended conditions>

Pick up point : Substrate area of LED ( area) (Shown below)

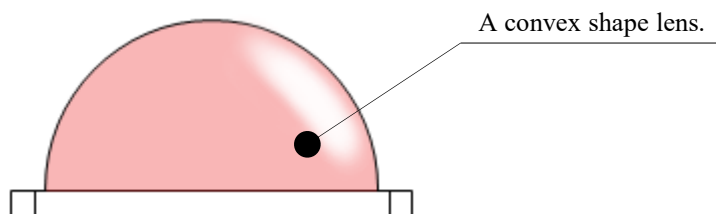
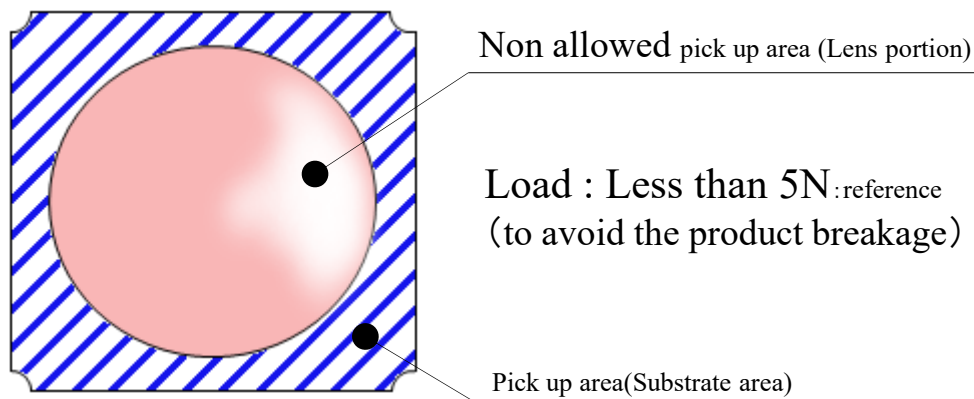

Please adjust the load, the pick up point, the nozzle diameter and etc. before mounting because the over load can cause the breakage of the surrounding of LED.

Recommendation of nozzle

- Internal diameter of nozzle : $\phi 3.45\text{mm}$ or more
- External diameter of nozzle : $\phi 3.75\text{mm}$ or less
- Pick-up position of nozzle : From the top of emboss tape
- If nozzle size is larger than opening part of emboss tape, pick-up should be done 0.1mm upper from emboss tape, or you can set holes (so that air can leak) on nozzle.

Handling precaution

【 Handling precautions for product mounting 】

< About exposed metal of side and bottom >

This LED device has exposed pattern on the non soldering area. Please avoid touching electroconductive material on exposed pattern area as it may connect with other electrode and short circuit.

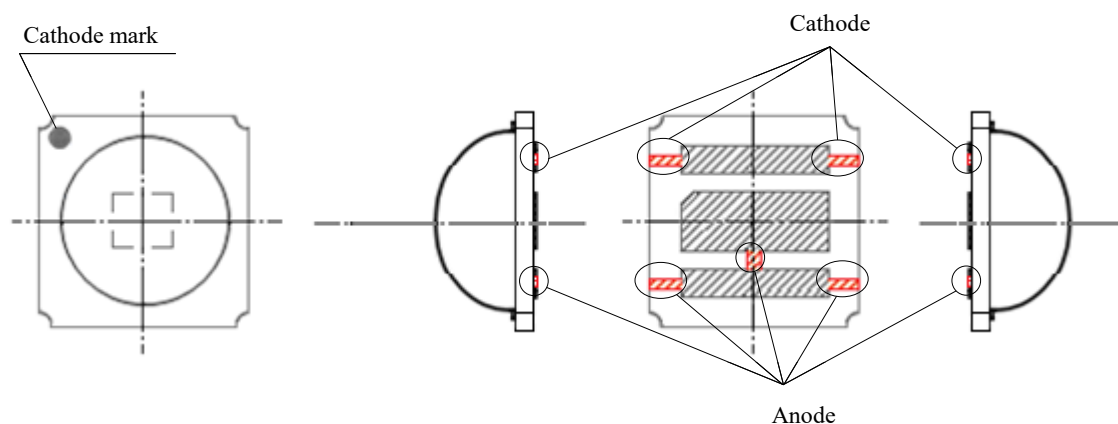

Packaging specifications

This product is shipped in moisture-proof packaging (as shown below) to minimize moisture absorption during shipping. However, in regards to storing the products, the use of dry-box under the following conditions is recommended. Moisture-proof bag as the packaging is made of anti-static material but packaging box is not.

【Recommended Storage Condition / Products Warranty Period】

Temperature	+5 to 30°C
Humidity	Under 60%

In the case of the package unopened, 12 months under 【 Recommended storage condition 】, Please avoid rapid transition from low temp. condition to high temp. condition and storage in corroding and dusty environment.

【Time elapsed after package opening】

This product is equivalent to IPC/JEDEC J-STD-020F MSL 2a. (4 weeks)

The package should not be opened until immediately prior to its use.

If any components should remain after their use, please seal the package and store them under the conditions described in the above 【 Recommended Storage Condition 】.

Baking process should be performed after putting out from package.

Baking conditions: 10h(MIN.), at $+60 \pm 5^{\circ}\text{C}$ just before use

Baking may be performed in the tape-reel form, however if it is performed with the reel stacked over one another, it may cause deformation

of the reels and taping materials, which may cause problems during production.

Please make sure that the product has cooled to normal temperature after performing the baking process.

Provided that, baking process shall be 2 times MAX.

Packaging specifications

VMPN1108MS-TR

【Moisture-proof packaging specification】

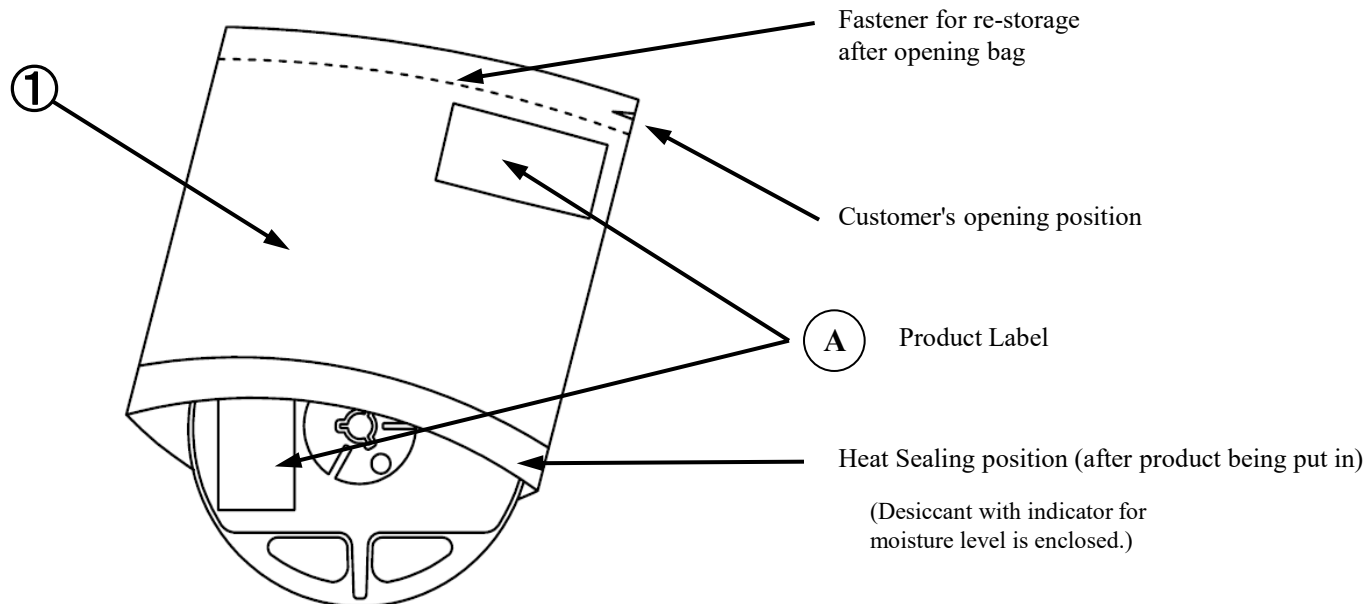

NO.	PART NAME	MATELRIAL	REMARKS
①	Moisture-proof bag with Aluminum layer	PET+Al+PE	with ESD protection

【Flow chart-package opening to mounting】

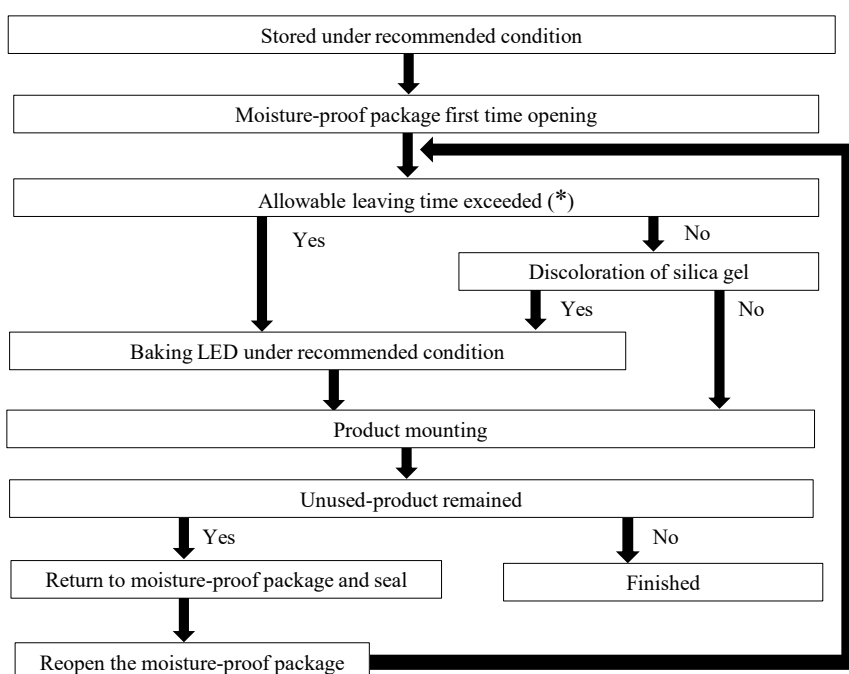

Allowable leaving time means the maximum allowable leaving time after opening package, which depends on each LED type. The allowable leaving time should be calculated from the first opening of package to the time when soldering process is finished. When judging if the allowable leaving time has exceeded or not, please subtract the soldering time. The allowable leaving time after reopening should be calculated from the first opening of package, or from the time when baking process is finished.

Packaging specifications

VMPN1108MS-TR

【Packing box】

(RoHS / ELV compliant)

Box type	Outline dimension L × W × H (mm)	Capacity of the box
Type A	280 × 265 × 45 (mm)	2 reels
Type B	310 × 235 × 265 (mm)	10 reels
Type C	440 × 310 × 265 (mm)	20 reels
Type D	305 × 270 × 65 (mm)	2 reels
Type E	370 × 280 × 270 (mm)	20 reels
Type F	530 × 380 × 270 (mm)	40 reels

The above measures are all the reference values.

The box is selected out of the above table by shipping quantity.

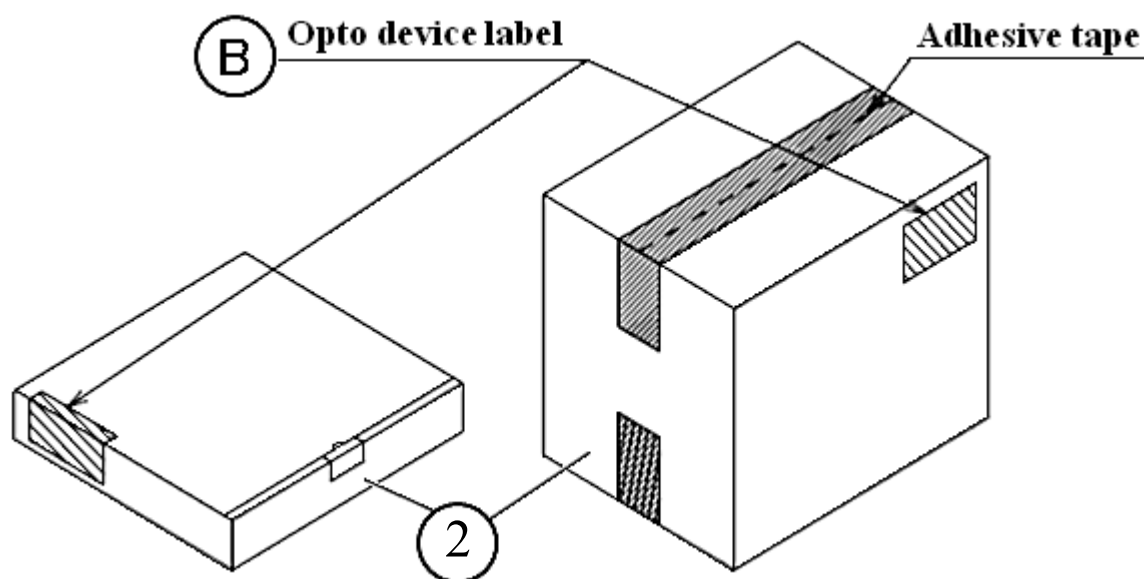
Type A

Material / Box : Cardboard

Type B, C

Material / Box : Cardboard , Partition : Cardboard

Type D

Material / Box : Cardboard

Type E, F

Material / Box : Cardboard

NO.	Part name	Material	Remarks
②	Packing box	Corrugated cardboard	without ESD protection

Packaging specifications

VMPN1108MS-TR

【Label specification】
(acc.to ISO/IEC 16388)

(A) Product label

The diagram shows a rectangular label with the following layout:

- Top header: STANLEY -STANLEY ELECTRIC CO.,LTD. -
- Field A: A box containing a barcode.
- Field B: A box containing a barcode.
- Field C: A box containing a code, followed by a closing parenthesis.)
- Field D: A box containing a code, followed by the text "PCS".
- Field E: A box containing a barcode.
- Field F: A box containing a code, followed by the text "Lot No." and a closing parenthesis.)
- Field G: A box containing a barcode.
- Field H: A box containing a code, followed by the text "MSL 2a".

- A. Parts number
- B. Bar-code for parts number
- C. Parts code (In-house identification code for each parts number)
- D. Packed parts quantity
- E. Bar-code for packed parts quantity
- F. Lot number & rank
(refer to Lot number notational system for details)
- G. Bar-code for lot number & rank
- H. MSL 2a

(B) Opto device label

The diagram shows a rectangular label with the following layout:

- Top header: STANLEY OPTO DEVICES
- Field A: A box containing a code, followed by the text "御中".
- Field B: A box containing a code, followed by a closing parenthesis.)
- Field C: A box containing a code, followed by a closing parenthesis.)
- Field D: A box containing a code, followed by a closing parenthesis.)
- Field E: A box containing a code, followed by the text "Q'TY" and a closing parenthesis.)
- Field F: A box containing a code, followed by the text "C/NO".
- Field G: A box containing a code, followed by the text "PCS".
- Field H: A box containing a barcode.
- Bottom header: STANLEY ELECTRIC CO.,LTD.

- A. Customer name
- B. Parts type
- C. Parts code
- D. Parts number
- E. Packed parts quantity
- F. Carton number
- G. Shipping date
- H. Bar-code for In-house identification number

<Remarks> Bar-code font : acc.to ISO/IEC 16388

Taping and reel specifications

VMPN1108MS-TR

【Appearance】
(acc.to IEC60286-3)

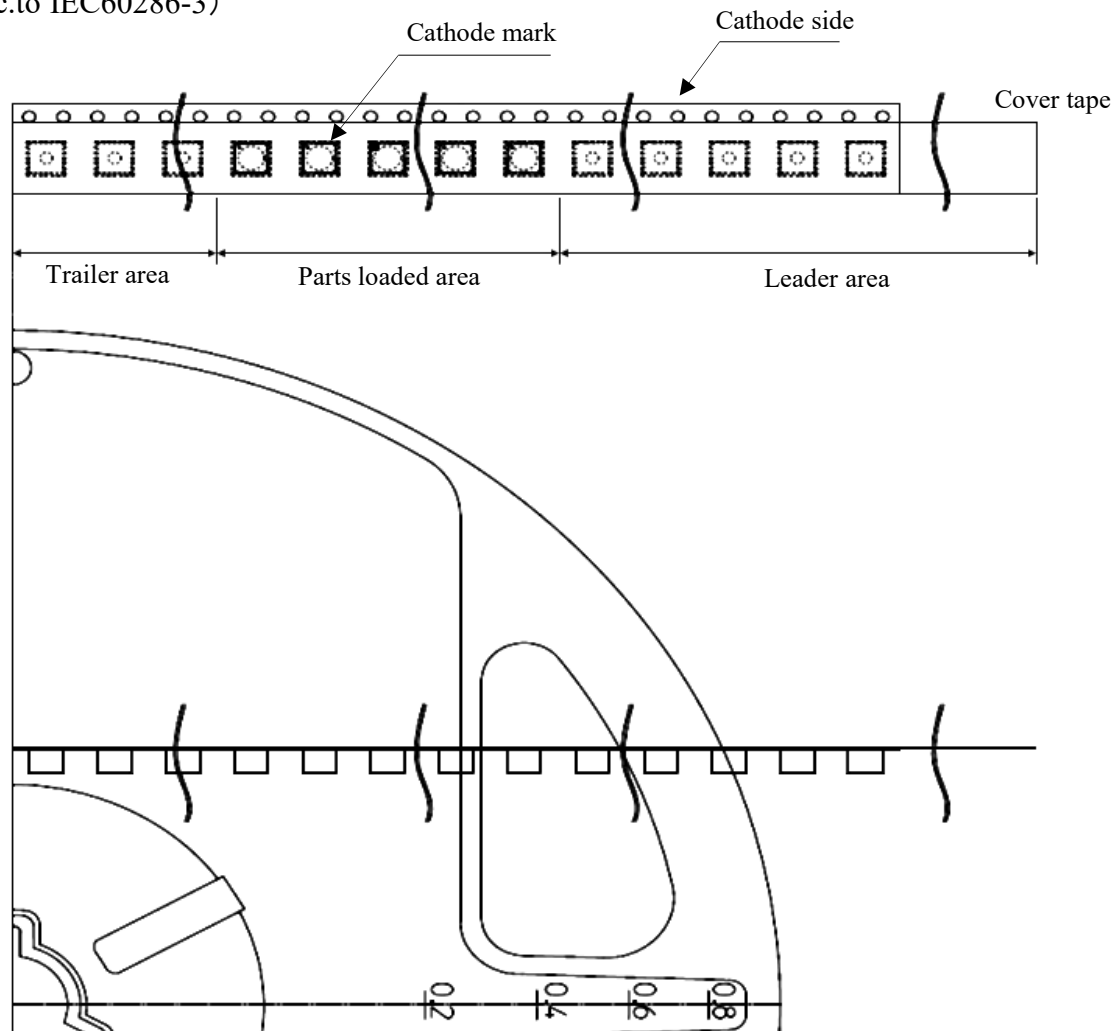

Note
"-TR" means Cathode Side of LEDs should be placed on the sprocket-hole side.

Items		Specifications	Remarks
Leader area	Cover-tape	Cover-tape shall be longer than 300mm without carrier-tape.	The end of cover-tape shall be held with adhesive tape.
	Carrier-tape	Empty pocket shall be more than 13 pieces. (longer than 100mm)	Please refer to the above figure for Taping & reel orientation .
Trailer area		Empty pocket shall be more than 20 pieces. (longer than 160mm)	The end of taping shall be inserted into a slit of the hub.

Taping and reel specifications

VMPN1108MS-TR

【Taping dimensions】

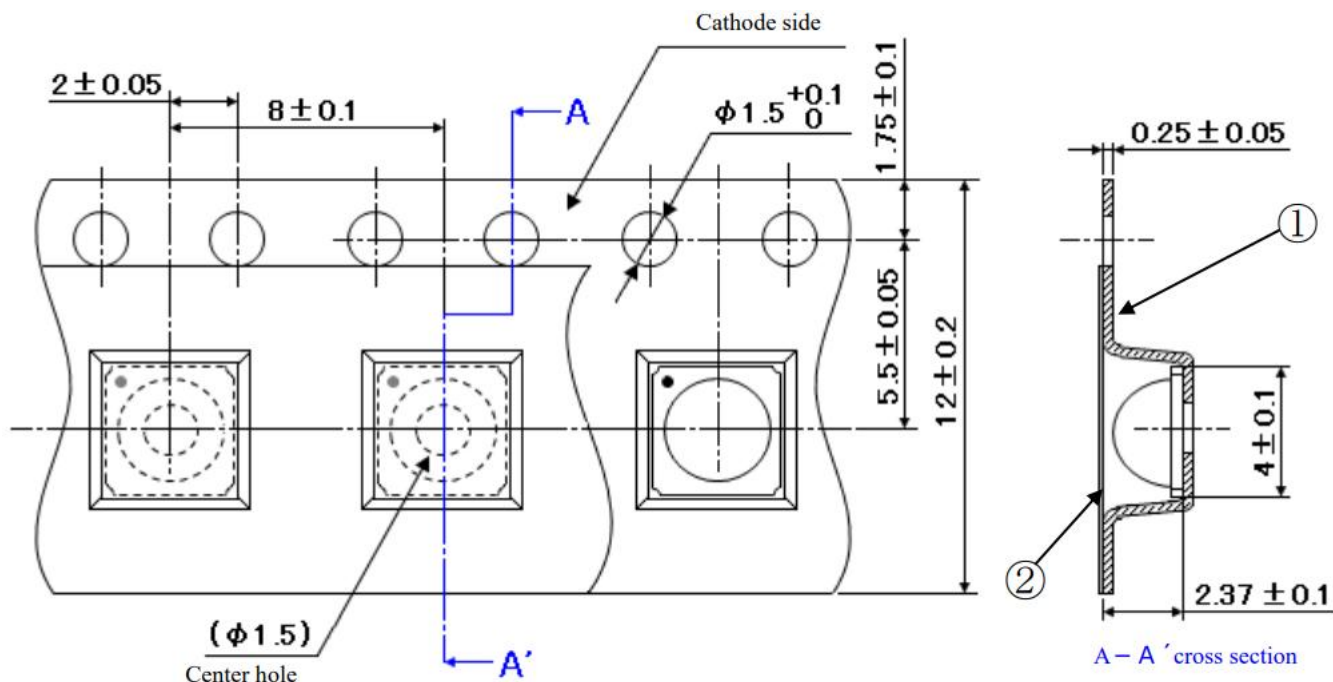

【Reel dimensions】

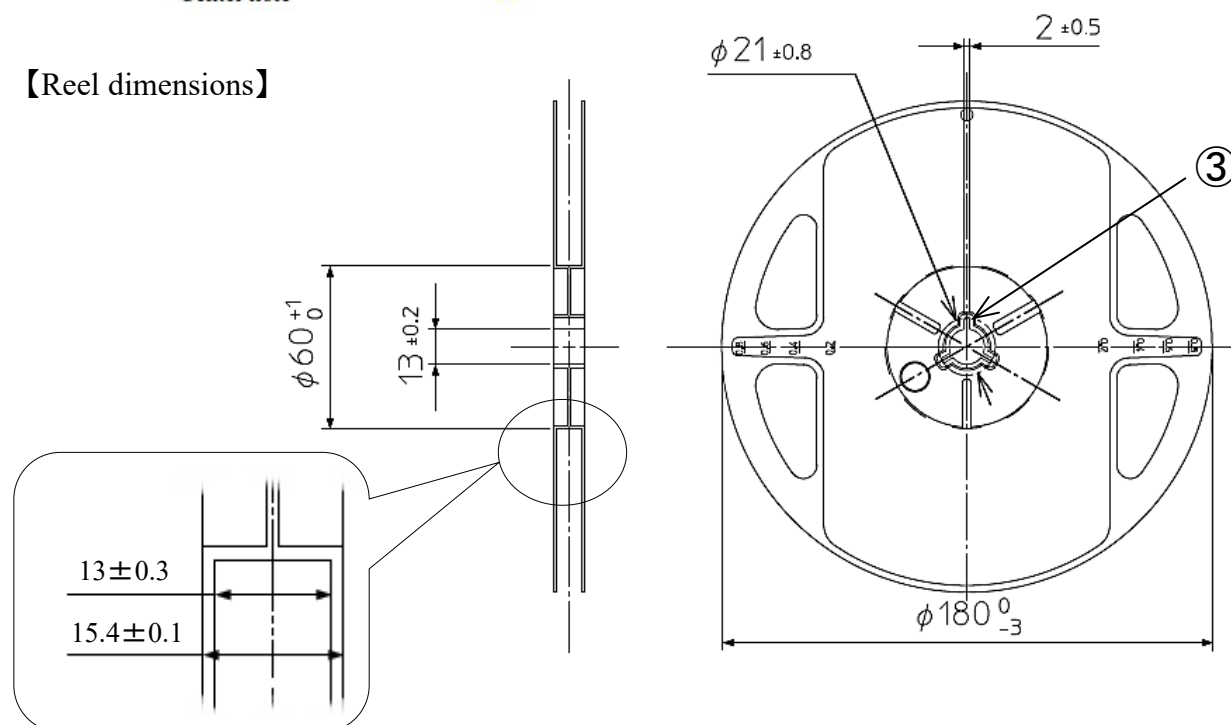

NO.	Part name	Remarks
①	Carrier tape	with ESD protection
②	Cover tape	with ESD protection
③	Carrier reel	with ESD protection

Taping and reel specifications

VMPN1108MS-TR

(acc.to IEC60286-3)

【Qty. per reel】

800parts/reel

Minimum Qty. per reel might be 100 parts when getting less than 800 parts. In such case, parts of 100-unit-qty. shall be packed in a reel and the qty. shall be identified on the label.

【Mechanical strength】

Cover-tape adhesive strength shall be 0.1~1.3N (An angle between carrier-tape and cover-tape shall be 170 deg.) Both tapes shall be so sealed that the contained parts will not come out from the tape when it is bent at a radius of 15mm.

【Others】

Reversed-orientation, Up-side down placing, side placing and out of spec. parts mixing shall not be held.
Empty pocket per reel is assumed until 1 piece.

Lot number notational system

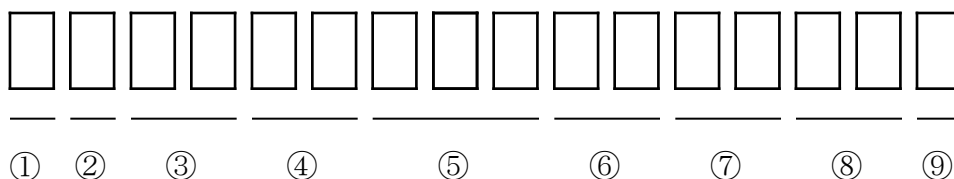

- ① - 1digit : Production location (mark identify alphabet)
- ② - 1digit : Production year (The last digit of production year 2025→5, 2026→6, 2027→7, 2028→8 …)
- ③ - 2digits : Production month (Jan. to Sep. , should be 01,02,03 …)
- ④ - 2digits : Production date
- ⑤ - 3digits : Serial number
- ⑥ - 2digits : Tape and reel following number
- ⑦ - 2digits : Radiant intensity rank
 (If radiant intensity rank is 1 digit, "-" shall be dashed on the place for the second digit.
 If there is no identified rank, "- -" is used to indicate.)
- ⑧ - 2digits : Wavelength rank
 (If wavelength rank is 1 digit, "-" shall be dashed on the place for the second digit.
 If there is no identified rank, "- -" is used to indicate.)
- ⑨ - 1digit : VF Rank (If rank is not defined, "-" is described.)

Correspondence to RoHS / ELV instruction

VMPN1108MS-TR

This product is in compliance with RoHS / ELV.

Prohibition substance and its criteria value of RoHS / ELV are as follows.

- RoHS instruction ... Refer to following 1 to 10.
- ELV instruction ... Refer to following 1 to 4.

2011/65/EU, (EU)2015/863

No.	Substance group name	Maximum permissible concentration value
1	Lead and its compounds	1,000ppm (0.1%)
2	Cadmium and its compounds	100ppm (0.01%)
3	Mercury and its compounds	1,000ppm (0.1%)
4	Hexavalent chromium compounds	1,000ppm (0.1%)
5	PBB : Polybrominated Biphenyls	1,000ppm (0.1%)
6	PBDE : Polybrominated Biphenyl Ethers	1,000ppm (0.1%)
7	DEHP : Bis (2-ethylhexyl) phthalate	1,000ppm (0.1%)
8	BBP : Butyl benzyl phthalate	1,000ppm (0.1%)
9	DBP : Dibutyl phthalate	1,000ppm (0.1%)
10	DIBP : Diisobutyl phthalate	1,000ppm (0.1%)

Special notice to customers using the products and technical information shown in this data sheet

- 1) The technical information shown in the data sheets are limited to the typical characteristics and circuit examples of the referenced products. It does not constitute the warranting of industrial property nor the granting of any license.
- 2) For the purpose of product improvement, the specifications, characteristics and technical data described in the data sheets are subject to change without prior notice. Therefore, it is recommended that the most updated specifications be used in your design.
- 3) When using the products described in the data sheets, please adhere to the maximum ratings for operating voltage, heat dissipation characteristics, and other precautions for use. We are not responsible for any damage which may occur if these specifications are exceeded.
- 4) The products that have been described to this catalog are manufactured so that they will be used for the electrical instrument of the benchmark (OA equipment, telecommunications equipment, AV machine, home appliance and measuring instrument).
The application of aircrafts, space borne application, medical equipment and nuclear power control equipment, etc. needs a high reliability and safety, and the breakdown and the wrong operation might influence the life or the human body. Please consult us beforehand if you plan to use our product for the usages of aircrafts, space borne application, transportation equipment, medical equipment and nuclear power control equipment, etc. except OA equipment, telecommunications equipment, AV machine, home appliance and measuring instrument.
- 5) In order to export the products or technologies described in this data sheet which are under the "Foreign Exchange and Foreign Trade Control Law," it is necessary to first obtain an export permit from the Japanese government.
- 6) No part of this data sheet may be reprinted or reproduced without prior written permission from Stanley Electric Co., Ltd.
- 7) The most updated edition of this data sheet can be obtained from the address below:
<http://www.stanley-components.com/en/>