

Data sheet

Part number : UGN1ZE140110-TR



2011/65/EU, (EU)2015/863
10 Substances regulation compliant



Lead-free solder heat resistant product



Package	Infrared VCSEL (Vertical Cavity Surface Emitting LASER) with Photodiode Peak wavelength : 940nm Outer dimension 3.5 x 3.5 x 1.225mm(L x W x H)
Product features	<ul style="list-style-type: none"> • AEC-Q102 compliant • Optical output power 10.1W (TYP.) @$I_F=6.0A$ (tw=0.3ms) • Equipped with a photo diode • Operating temperature : -40 to +105 deg. • Lead-free soldering compliant • RoHS : 2011/65/EU, (EU)2015/863 compliant

Recommended applications

- Automotive use (OMS : Occupancy monitoring system) etc.
- TOF (Time Of Flight) sensor, Security equipment etc.

CAUTION

This product is classified as **Safety Standard 1** of IEC60825-1 and CFR Part1040.10.
(calculated at Optical output power 10.1W @ $I_F=6.0A$ (tw=0.3ms).

If the diffuser is damaged or dropped and the laser beam is directly exposed, **it may be equivalent to Class 3B**.
Be careful not to drop the diffuser.

Risk group 3B is classified as "high" concerning potential hazards to the human body;
it is the highest risk group "that causes damage even from temporary or short exposure with laser radiations".
Safety precautions should be required.



WARNING

- This product **emits strong Infrared laser light when it is lit up.**
- **Do not look directly into the light source, for it could damage your eyes.**
- Should it be necessary to observe the product while it is being lit,
always use protective glasses that block infrared laser light.
- Please also take sufficient safety measures against light leakage, etc.,
in order to avoid any influence on the human body.

Outline dimensions

UGN1ZE140110-TR

Unit : mm
 Weight : 41.2mg
 Tolerance : ±0.150

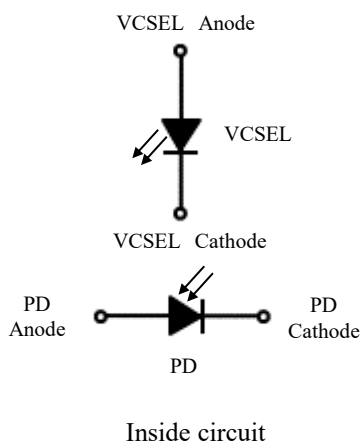
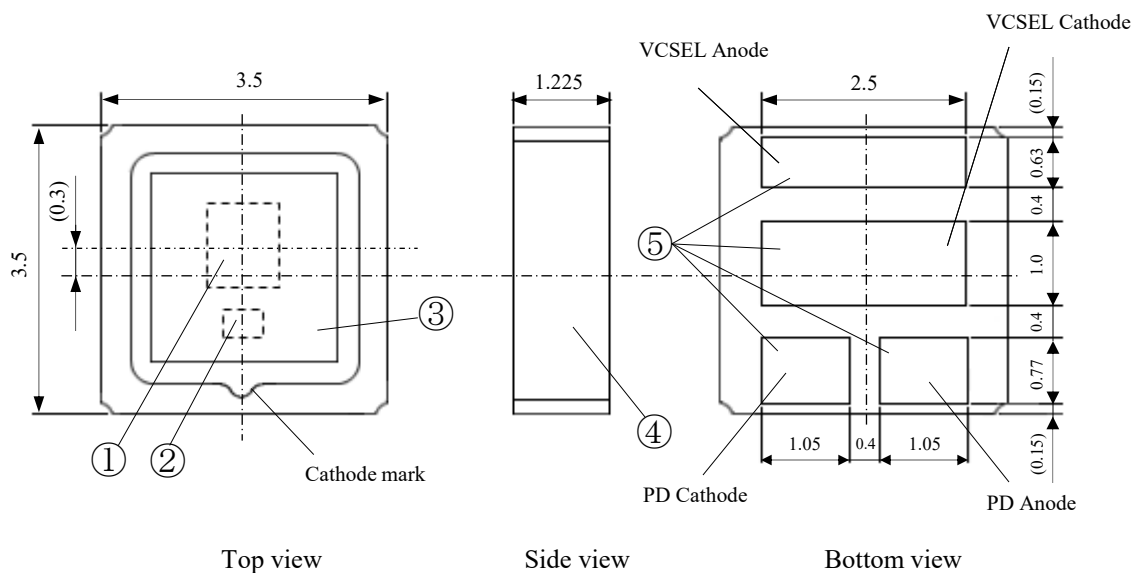

No.	Part name	Materials	Qty.
①	VCSEL die	-	1
②	PD die	Si	1
③	Diffuser	Glass / Polymer	1
④	Substrate	Ceramic	1
⑤	Electrode	Au plating	Anode : 2 Cathode : 2

Recommended pad

Unit : mm
 Tolerance : ±0.150

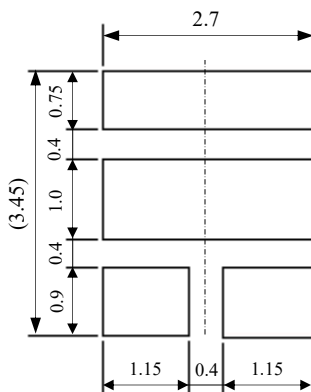

Specifications

【 Product overview 】

Infered vertical cavity surface emitting LASER

【 Absolute maximum ratings 】

Item	Symbol	Maximum ratings	Units	
Operating temperature	T_{opr}	-40 to +105	°C	Note 1
Storage temperature	T_{stg}	-40 to +125	°C	Note 1
Electrostatic discharge threshold "HBM"	V_{ESD}	2	kV	
Peak temperature of reflow soldering	T_{sld}	260	°C	
VCSEL	Junction temperature	T_j	150	°C
	Forward current	I_F	2	A
	Pulse forward current ($tw \leq 0.1\text{msec}$, $duty \leq 1\%$)	I_{FRM}	7.0	A
PD	Power dissipation	P_d	25	mW

Note 1 The ranges of operating and storage temperature are not applied to taping condition.

Note 2 The symbol "tw" stands for time of pulse width.

Note 3 Please do not input reverse voltage or reverse current to VCSEL die for prevent the destructic

【 Thermal characteristics 】

($T_a=25^\circ\text{C}$)

Item	Symbol	Typ.	Max.	Units
Thermal resistance (Junction - Soldering Point)	$R_{th(j-s)}$	9.5	13.0	°C/W

Specifications

【 Electro-optical characteristics 】

(Ta=25°C)

Item		Symbol	Conditions	Min.	Typ.	Max.	Units	
VCSEL	Optical output power (Peak)	P _O	I _F = 6.0A (tw = 0.3msec)	9.3	10.1	10.9	W	Note 2
	Threshold current	I _{TH}	-	-	0.5	-	A	
	Center wavelength	λ _c	I _F = 6.0A (tw = 0.3msec)	930	940	950	nm	Note 2
	Spectral bandwidth at 50% of I _{max}	Δλ	I _F = 6.0A (tw = 0.3msec)	-	1.8	-	nm	Note 2
	Field of illumination	FOI (x)	I _F = 6.0A (tw = 0.3msec)	-	140	-	deg.	Note 2,4
		FOI (y)		-	110	-		
	Response time	tr / tf	10 - 90%	-	1.0	-	ns	
Forward voltage	V _F	I _F = 6.0A (tw = 0.3msec)	3.4	3.8	4.2	V	Note 2	
PD	Photo current	I _p	I _F = 6.0A (VCSEL) V _R = 5V	3.2	7.5	-	mA	
	Dark current	I _d	V _R = 5V	-	-	10.0	nA	
	Junction capacitance	C _j	V _R = 3V, H = 0, F = 1MHz	-	0.7	-	pF	

Note 4 Viewing Angle at 50% Optical output power, FOI(x) and FOI(y) are as shown in the right figure.

Note 5 Tolerance : P_O = +/- 7%, λ_c = +/- 1nm, V_F = +/- 0.1V

Note 6 This product emits strong Infrared laser light when it is lit up.

Please do not look directly into the light source, for it could damage your eyes.

Should it be necessary to observe the product while it is being lit, always use protective glasses that block infrared laser light.

Please also take sufficient safety measures against light leakage, etc., in order to avoid any influence on the human body.

Note 7 When the handle this products, please careful the glass part on the top of product.

It may be broken or dropped.

Note 8 Products incorporating this product have to comply with the safety precautions set in IEC60825-1 "Safety of Laser Products".

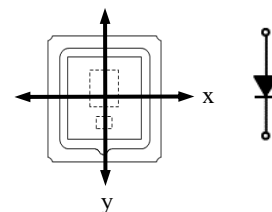
**CAUTION**

This product is classified as **Safety Standard 1** of IEC60825-1 and CFR Part1040.10. (calculated at Optical output power 2.8W @I_F=4A (tw=0.3ms).

If the diffuser is damaged or dropped and the laser beam is directly exposed, **it may be equivalent to Class 3B**. Be careful not to drop the diffuser.

Risk group 3B is classified as "high" concerning potential hazards to the human body; it is the highest risk group "that causes damage even from temporary or short exposure with laser radiations". Safety precautions should be required.

Technical data

UGN1ZE140110-TR

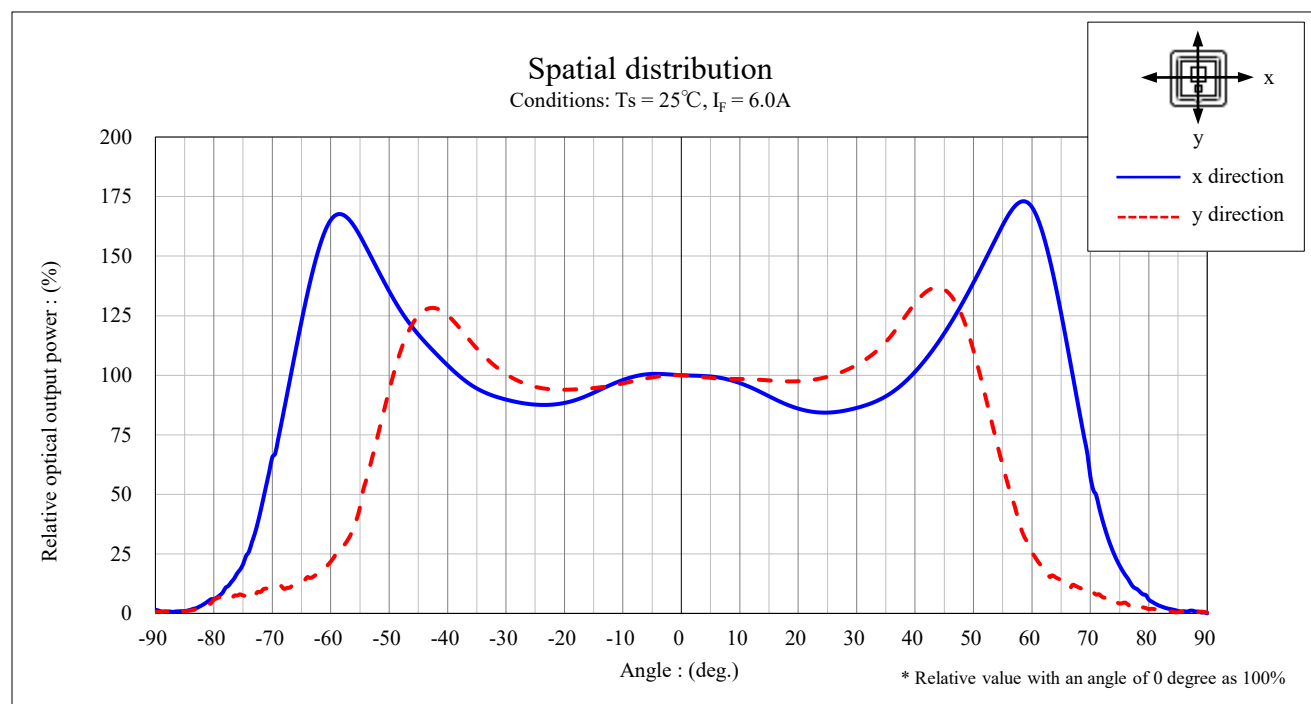
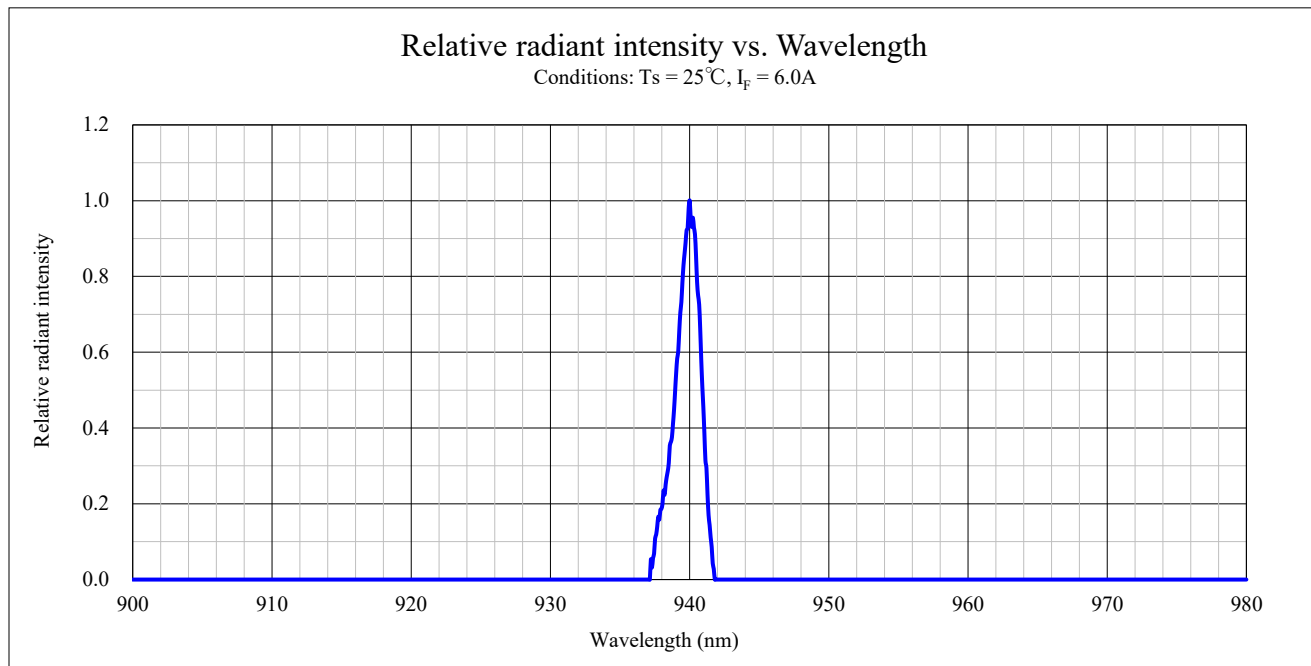

Technical data

UGN1ZE140110-TR

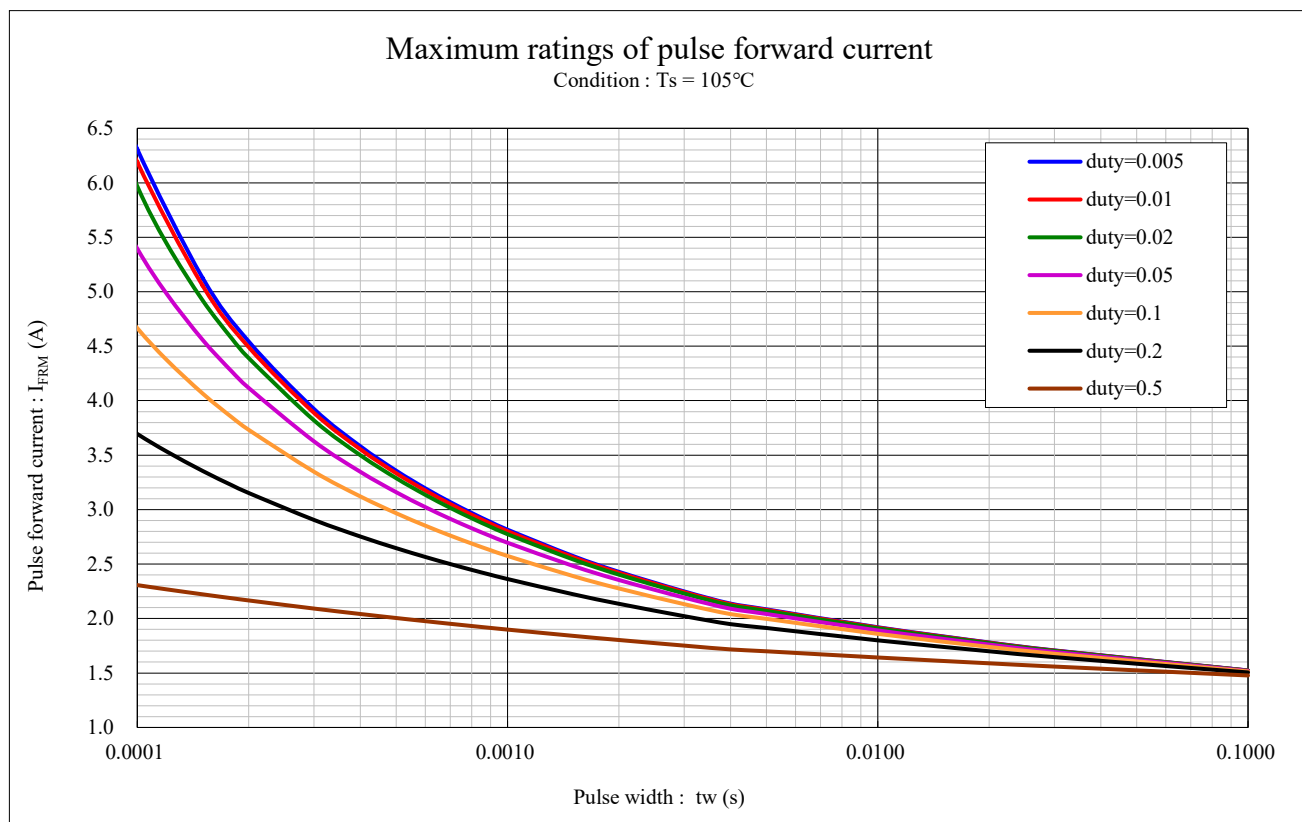
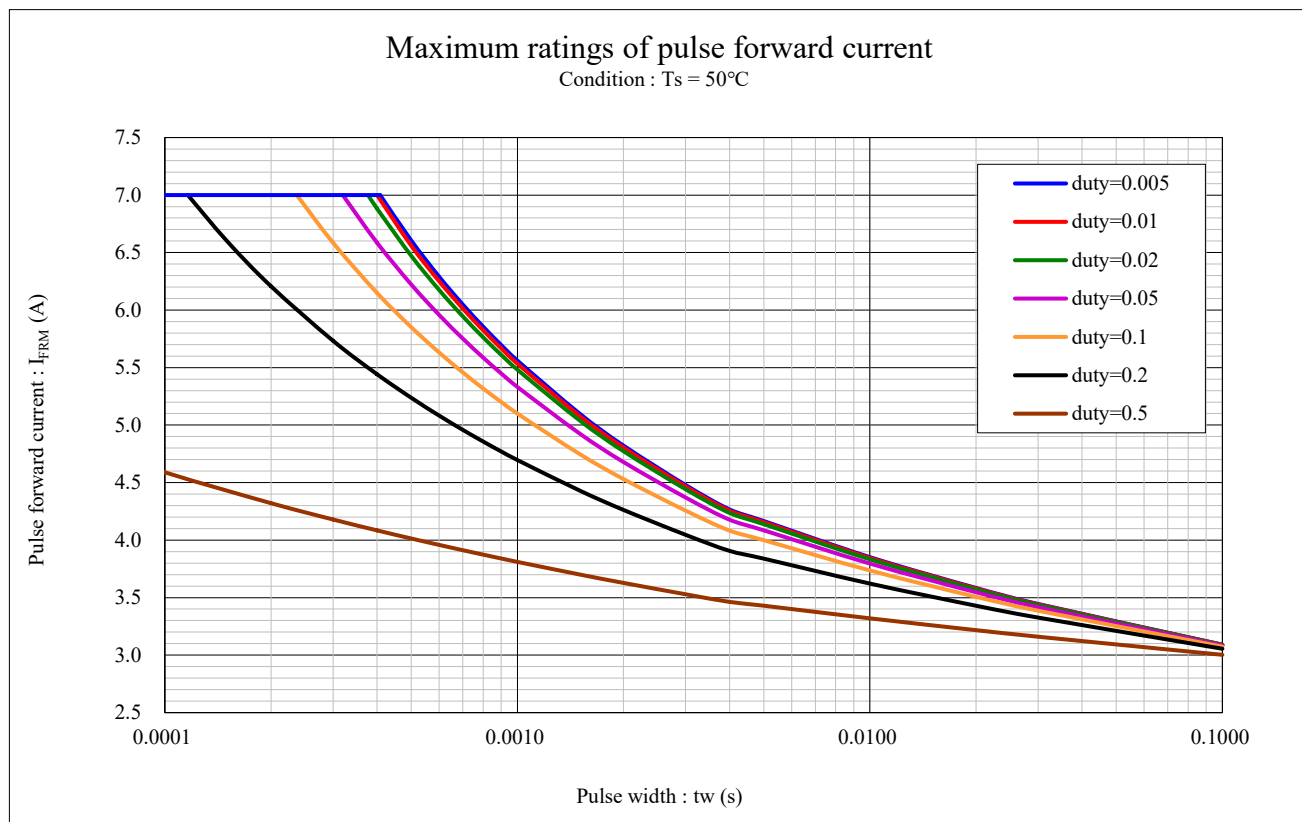

Technical data

UGN1ZE140110-TR

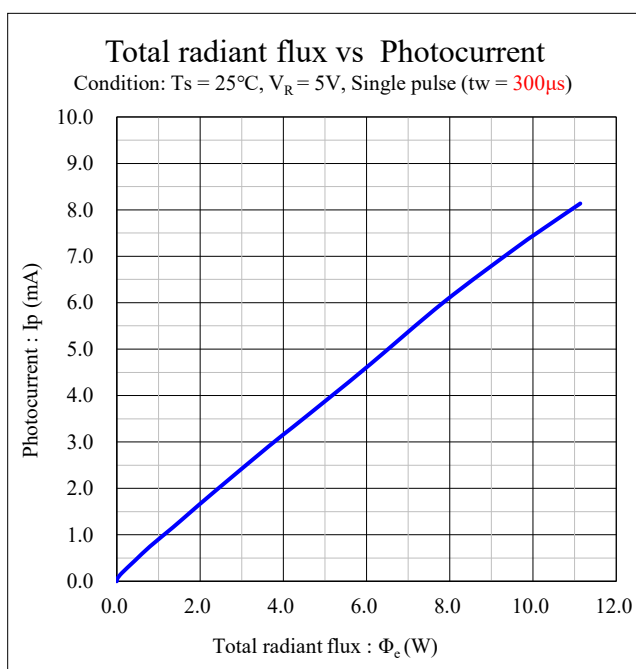
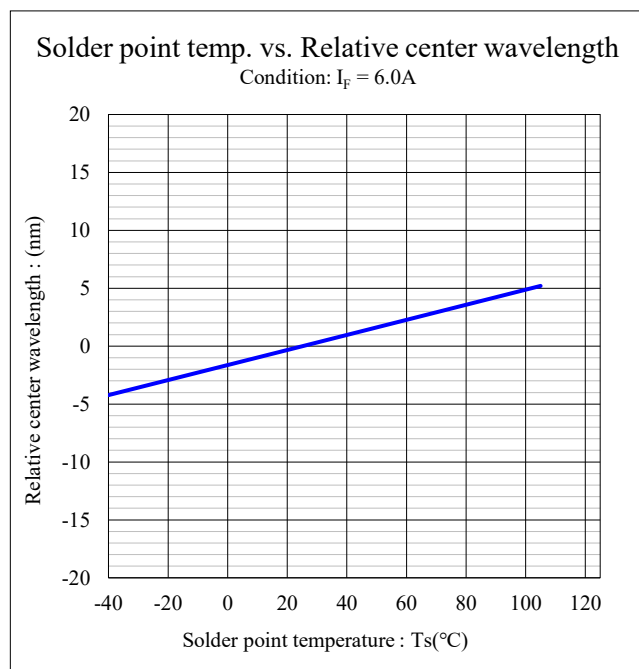
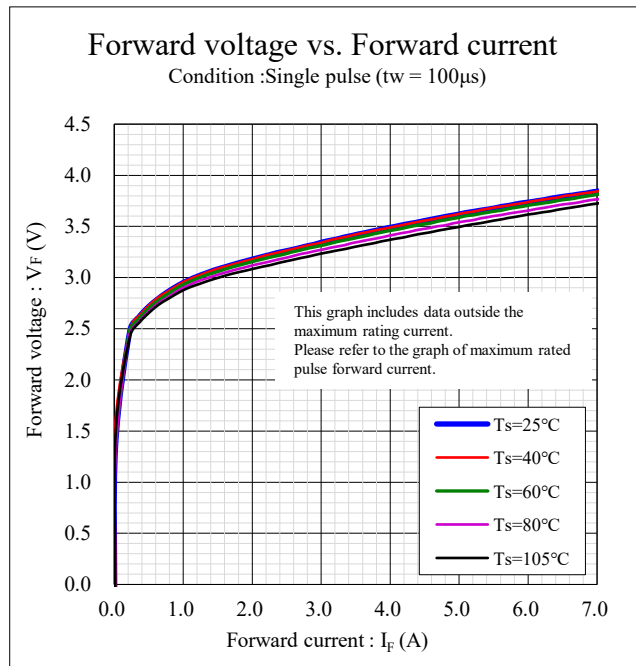
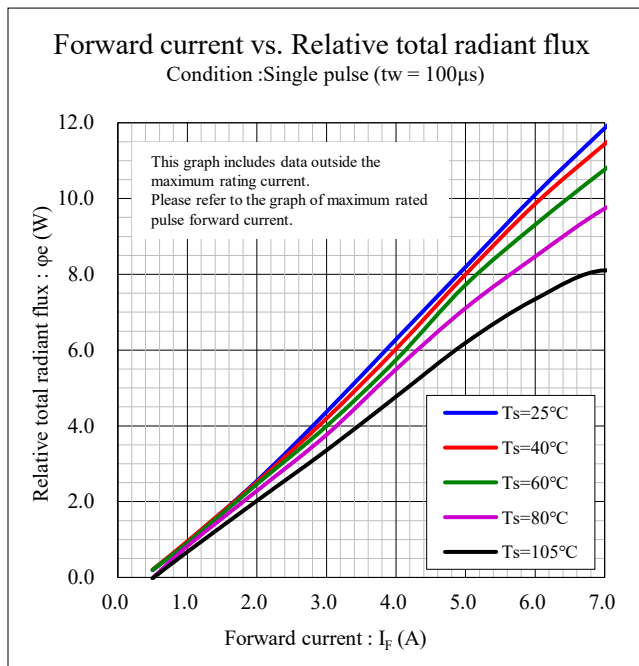

Technical data

UGN1ZE140110-TR

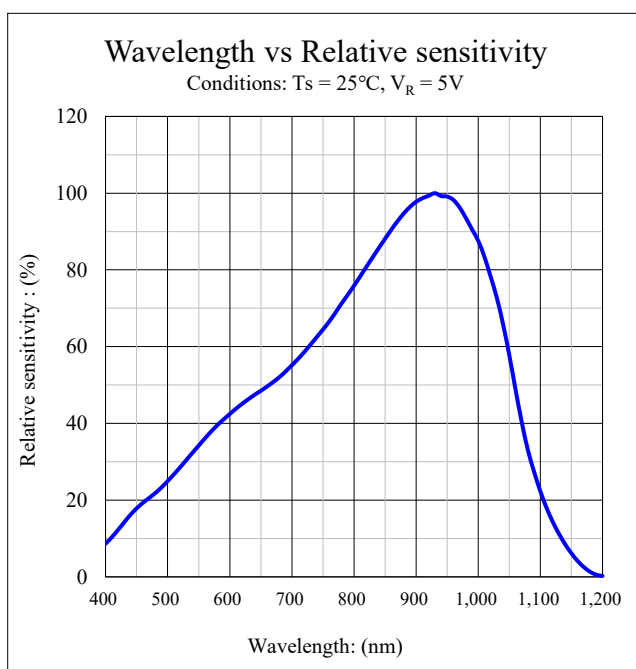
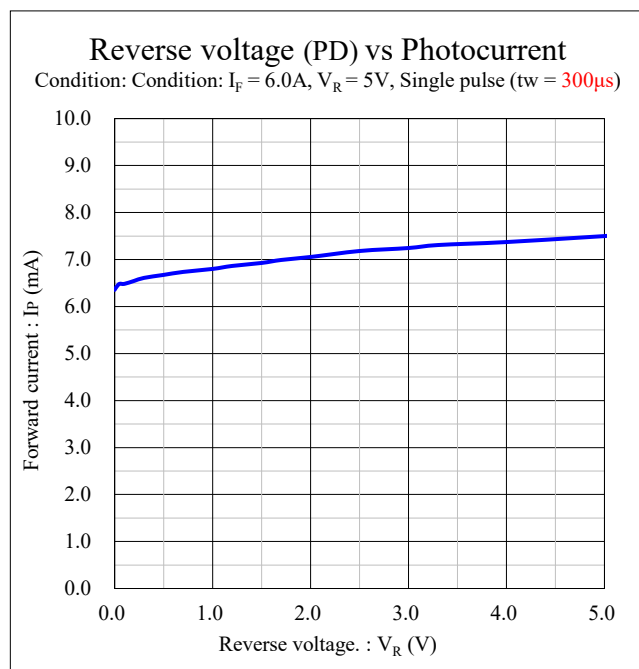
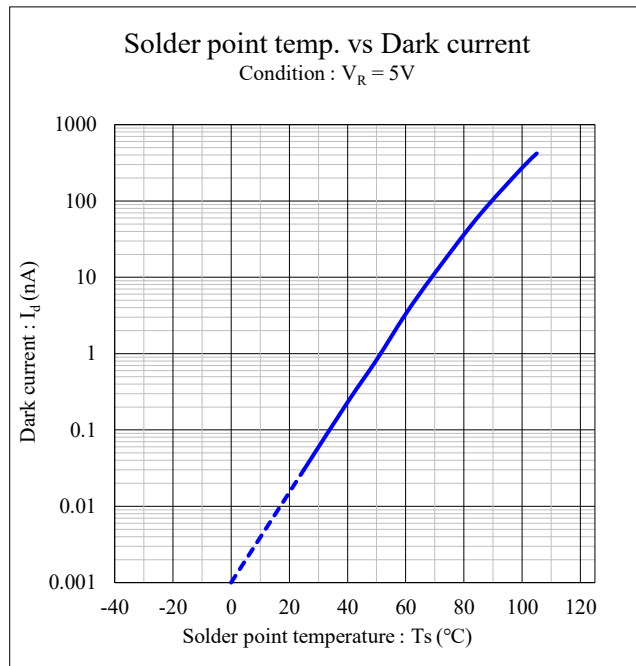
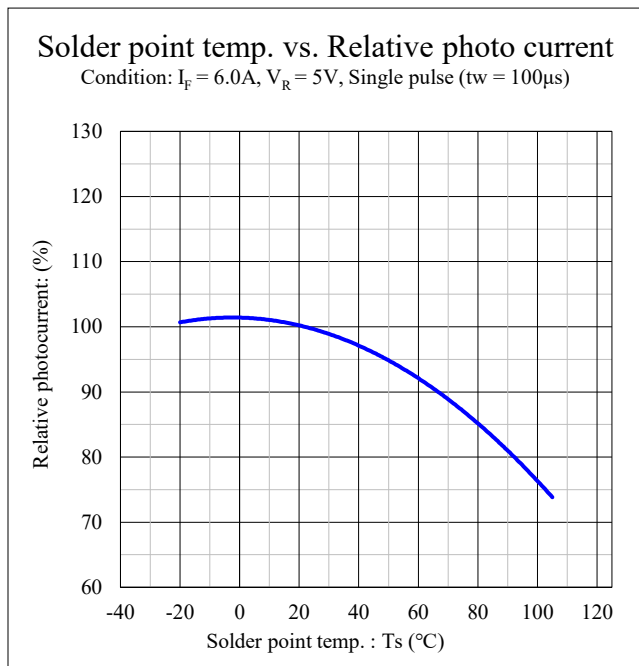

Soldering condition

【Soldering precaution】

1. Heat stress during soldering will influence the reliability of products, however that effect will vary on heating method. Also, if components of varying shape are soldered together, it is recommended to set the soldering pad temperature according to the component most vulnerable to heat (e.g., VCSEL).
2. The products constituent parts, including the resin, do not stabilize immediately after the soldering. Any mechanical stress may cause damage to the products. Please avoid stacking the PCBs, or any other storage method which may cause the PCBs to bend, also, prevent contact of products with any materials.
3. The recommended temperature profile for reflow soldering is listed as the top surface temperature. This is due to the fact that temperature distribution varies on heating method, PCB material, other components in the assembly, and concentration of the parts mounted.
In general, when FR-4 PCB is mounted with VCSEL device only and heated via far infrared and hot air, the temperature difference between PCB and VCSEL's diffuser surface will be around 5-10°C.
Please do not repeat the heating process during reflow more than two times.

【【Recommended reflow soldering condition】】

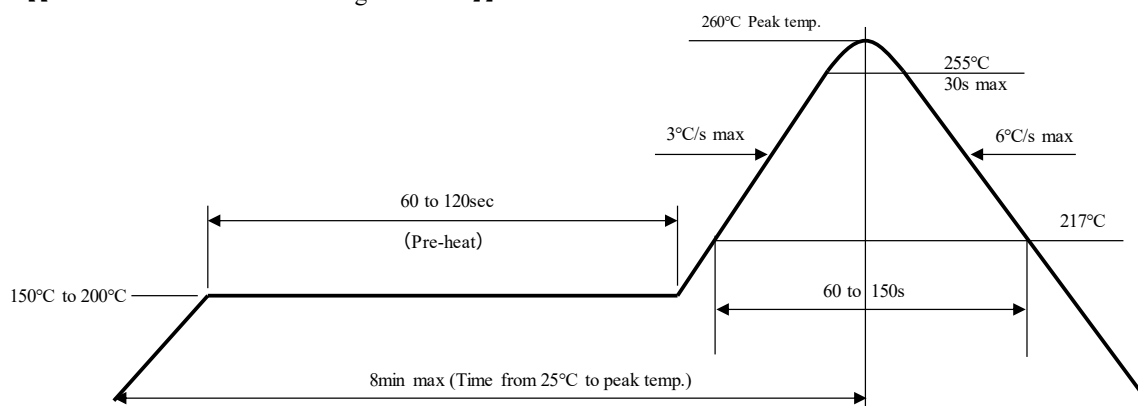

Note 1 Temperature Profile for the reflow should be set to VCSEL top diffuser surface temperature, which is the maximum temperature for soldering.
Lowering the heating temperature and decreasing heating time is very effective in achieving higher reliability.

Note 2 The reflow soldering process should be done 2 times Max.
The interval between first and second process should be as short as possible to prevent absorption of moisture to product.
Please cool down the product temperature at room temperature after soldering, then start the second process.

4. When using a metal PCB, the solder may crack and problems may occur due to major stress on the soldered portion caused by thermal shock. Please carry out a thorough advance verification before use. For the metal PCB's insulation, it is recommended to use stress-reducing materials.
5. Manual soldering and flow soldering (dip soldering) are not recommended for this product.
6. Basically, do not wash. Diffusers and cases may be damaged by some chemicals, including cleaning agents that replace CFCs, thus causing problems.
Cleaning with ultrasonic is not recommended.

Handling precaution

UGN1ZE140110-TR

【For electric static discharge (ESD)】

1. Electrification/Static electricity protection

Stanley recommends the following precautions in order to avoid product (die) damage from static electricity , when an operator and other materials electrified by friction coming in contact with the product.

- ① Do not place electrified non-conductive materials near the VCSEL product.
Avoid VCSEL products from coming in contact with metallic materials; should the metallic material be charged, sudden surge voltage will most likely damage the product.
- ② Avoid working process which may cause the VCSEL product to slide/rub against other materials.
- ③ Install ground wires for any equipment, which can be installed with such measures to avoid static electricity.
- ④ Prepare a ESD protective area by placing Conductive Mattress (1M Ω) and Ionizer to remove any static electricity.
- ⑤ Operators should wear a protective wrist-strap.
- ⑥ Operators should wear conductive work-clothes, shoes and work on a conductive floor.
- ⑦ To handle the products directly, Stanley recommends the use of ceramic (and not metallic) tweezers.

2. Working environment

- ① Dry environment is more likely to cause static electricity.
Although dry environment is ideal during storage state of VCSEL products, during the soldering process Stanley recommends an environment with approximately 50%rh humidity.
- ② Recommended static electricity level in the working environment is less than 150V, which is the same value as Integrated Circuits.

Handling precaution

UGN1ZE140110-TR

【Other precautions】

1. The products are designed to achieve the highest performance reliability, however they can be influenced by usage conditions.
2. Absolute Maximum Ratings are set to prevent VCSEL products from breaking due to extreme stress (temperature, current, voltage, etc.). Usage conditions must never go above the ratings, nor the factors reach the rating level simultaneously.
3. To achieve the highest performance reliability it is necessary to take into account factors such as forward voltage adjusted to the usage temperature condition, derating of the power consumption, and other variable factors.
4. Please insert Straight Protective Resistors into the circuit in order to stabilize VCSEL operations and to prevent the device from overheating.
5. Please avoid to using the products with materials and products that contain sulfur and chlorine elements because the reliability may be decreased.
Please keep in desiccator before and after mounting, to prevent the products from being affected by corrosive gas. Also please make sure there isn't any gas in the surrounding area or entering from outside when using the products.
6. Please check the actual life time performance in the assembly at your company because the specification sheets are described for VCSEL device only.
7. When there is a process of supersonic wave welding etc. after mounting the product, there is a possibility of affecting on the reliability of junction part in package (junction part of die bonding and wire bonding). Please make sure there is no problem before using.
8. The products are designed to perform without failure in the recommended usage conditions. However, please take the necessary precautions to prevent fire, injury, and other damage from these unexpected failures of VCSEL or diffuser.
9. The products are manufactured to be used for ordinary electronic equipment. Please contact our sales staff in advance when exceptional quality and reliability are required, when the failure or malfunction of the products might directly jeopardize life or health (such as for airplanes, aerospace, medical applications, nuclear reactor control systems and so on).
10. Please avoid overload to the product when using tweezers to pick up VCSELS. Overload might cause deformation, disconnection, chip-outs and consequently lead to lighting failure. Tweezers with flat tips is recommended, please avoid using tweezers with sharp tips.
Tip material of tweezer : Resin (PEEK etc.)
11. Pay attention to handling and storage of VCSELS even after mounting, because overload caused by stacking PCBs and shock due to dropping and crashing might also lead to deformation, disconnection, and chip-outs.
12. In the processes of water pressure during cleaning, air pressure, drying and other processes after mounting, overload to diffuser should be avoided.

Handling precaution

UGN1ZE140110-TR

【Other precautions】

13. Please do not touch the diffuser surface, the contamination of diffuser can affect the optical characteristics.
14. Please adjust the load, the pick up point, the nozzle diameter and etc. before mounting because the over load can cause the breakage of the diffuser. (Recommend load condition : Less than 5N)
15. Products incorporating this product have to comply with the safety precautions set in IEC60825-1 "Safety of Laser Products".
16. This product emits strong Infrared laser light when it is lit up.
Please do not look directly into the light source, for it could damage your eyes.
Should it be necessary to observe the product while it is being lit, always use protective glasses that cut laser light, as well as protective masks and gloves, etc. in order not to expose your skin to the light.
Please also take sufficient safety measures against light leakage, etc., in order to avoid any influence on the human body.
17. This product generates heat when it is lit up. Since there is a risk of adverse effects on the human body and surrounding parts, please take sufficient safety measures against smoke, ignition and deterioration of parts.
18. Stanley recommends to mount for VCSEL on an aluminum circuit board with low stress characteristics.
19. Dew condensation or icing may cause output fluctuation, light distribution fluctuation, malfunction, insulation deterioration. Please take care to avoid Dew condensation and icing.
20. Oils and gases from the outside may be adsorbed on the diffuser lens and cause discoloration. Please make sure there is no problem before using.
21. Please pay attention not to let strong light such as sunlight directly enter the product as it affects the photocurrent. As an example, in the case of monochromatic light at 940 nm, 100 mW/cm² of light incident on the product will affect the diffuser removal decision.
22. The photocurrent may fluctuate due to the reflected light from the parts near the product. Please confirm the photocurrent in actual use with your company before using.
23. The dark current changes depending on the VCSEL drive current and ambient temperature.
Please refer to the technical data for the current setting of the diffuser detection.
24. Keep out of reach of children.
25. The formal specification sheets should be exchanged and signed by both parties.

Handling precaution

【 Handling Precautions for product mounting 】

<Recommended conditions>

Pick up point : Lamp housing area of product ( area) (Shown below)

Please pick up the shaded area only due to because the diffuser is made of silicate glass.
Nozzle contact with the part except the shaded area may cause damage to the diffuser.

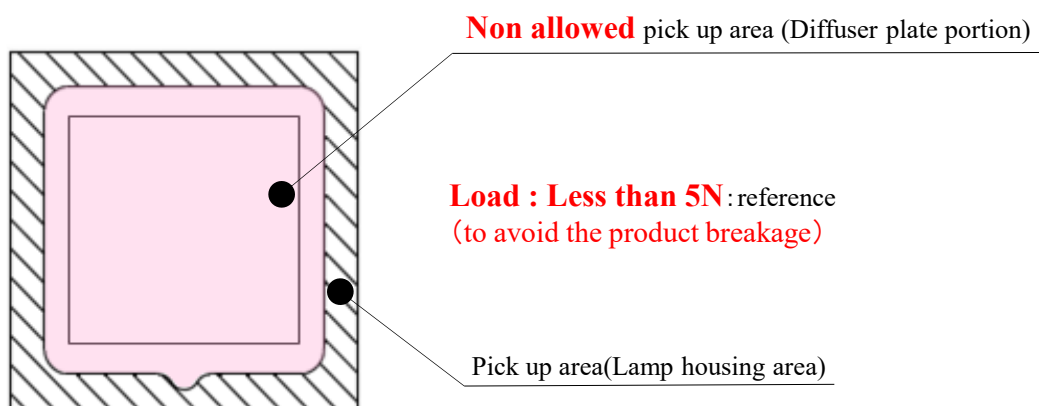

Please adjust the load, the pick up point, the nozzle diameter and etc.
before mounting because the over load can cause the breakage of the products.

Packaging specifications

This product is shipped in moisture-proof packaging (as shown next page) to minimize moisture absorption during shipping. However, in regards to storing the products, the use of dry-box under the following conditions is recommended. Moisture-proof bag as the packaging is made of anti-static material but packaging box is not.

【Recommended storage condition / Products warranty period】

Temperature	+5 to 30°C
Humidity	Under 60%RH

In the case of the package unopened, 12 months under 【 Recommended storage condition 】. Please avoid rapid transition from low temp. condition to high temp. condition and storage in corroding and dusty environment.

【Time elapsed after package opening】

This product is equivalent to IPC/JEDEC J-STD-020F MSL 3.

The package should not be opened until immediately prior to its use.

If any components should remain after their use, please seal the package and store them under the conditions described in the above 【 Recommended Storage Condition 】.

Baking process should be performed after putting out from package.

Baking conditions: over 10h, at $+60 \pm 5^{\circ}\text{C}$ just before use

Baking may be performed in the tape-reel form, however if it is performed with the reel stacked over one another, it may cause deformation of the reels and taping materials, which may cause problems during production. Please make sure that the product has cooled to normal temperature after performing the baking process. Provided that, baking process shall be 2 times MAX.

Packaging specifications

【Moisture-proof packaging specification】

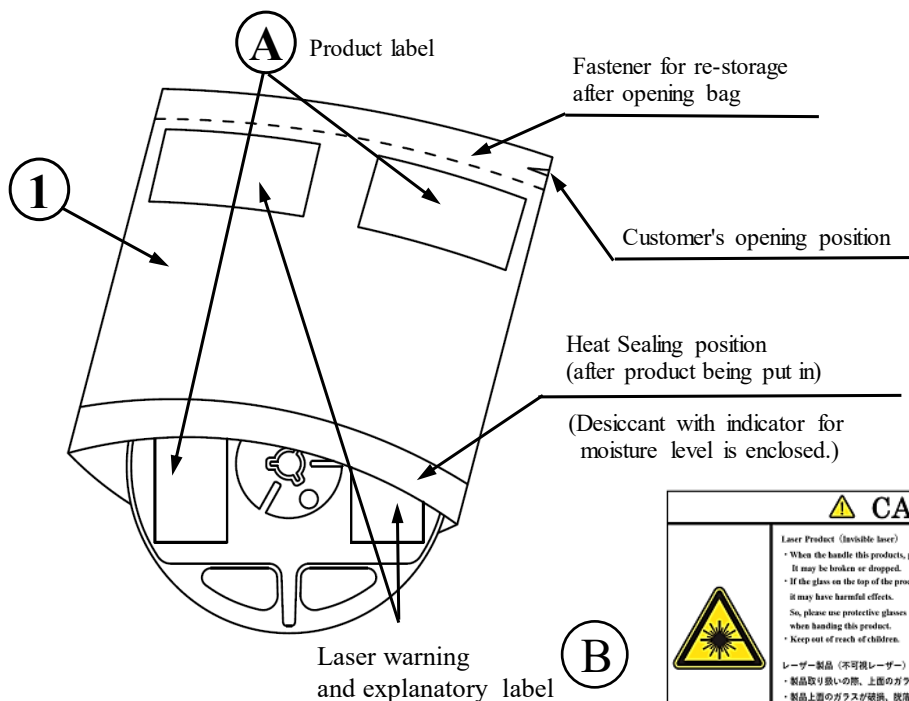

⚠ CAUTION 警告	
	<p>Laser Product (invisible laser)</p> <ul style="list-style-type: none"> When the handle this product, please careful the glass part on the tip of product. It may be broken or dropped. If the glass on the top of the product is broken or dropped and the laser beam hits to your eyes directly, it may have harmful effects. So, please use protective glasses that block infrared beam to prevent exposure to the eyes, when handling this product. Keep out of reach of children.
	<p>レーザー製品 (不可視レーザー)</p> <ul style="list-style-type: none"> 製品取り扱いの際、上部のガラス部にご注意ください。破損、脱落の可能性があります。 製品上部のガラスが破損、脱落した状態で目が強ばくと有害な影響を及ぼす可能性があります。 本製品を取り扱う際は、目への強ばくを防ぐために、赤外線カット作用のある保護メガネを使用してください。 幼児の手の届かない所に置いて下さい。

No.	Part name	Material	Remarks
①	Moisture-proof bag with aluminum layer	PET+Al+PE	with ESD protection

【Flow chart-package opening to mounting】

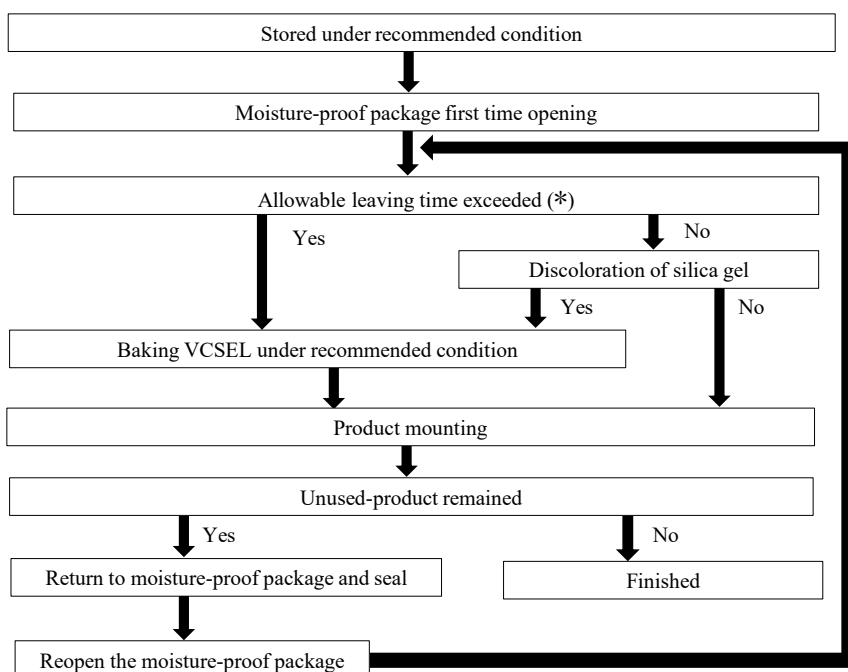

Allowable leaving time means the maximum allowable leaving time after opening package, which depends on each VCSEL type.

The allowable leaving time should be calculated from the first opening of package to the time when soldering process is finished.

When judging if the allowable leaving time has exceeded or not, please subtract the soldering time after reopening should be calculated from the first opening of package, or from the time when baking process is finished.

Packaging specifications

UGN1ZE140110-TR

【Packing box】

(RoHS / ELV compliant)

Box type	Outline dimension L × W × H (mm)	Capacity of the box
Type A	280 × 265 × 45 (mm)	2 reels
Type B	310 × 235 × 265 (mm)	10 reels
Type C	440 × 310 × 265 (mm)	20 reels
Type D	305 × 270 × 65 (mm)	2 reels
Type E	370 × 280 × 270 (mm)	20 reels
Type F	530 × 380 × 270 (mm)	40 reels

The above measures are all the reference values.

The box is selected out of the above table by shipping quantity.

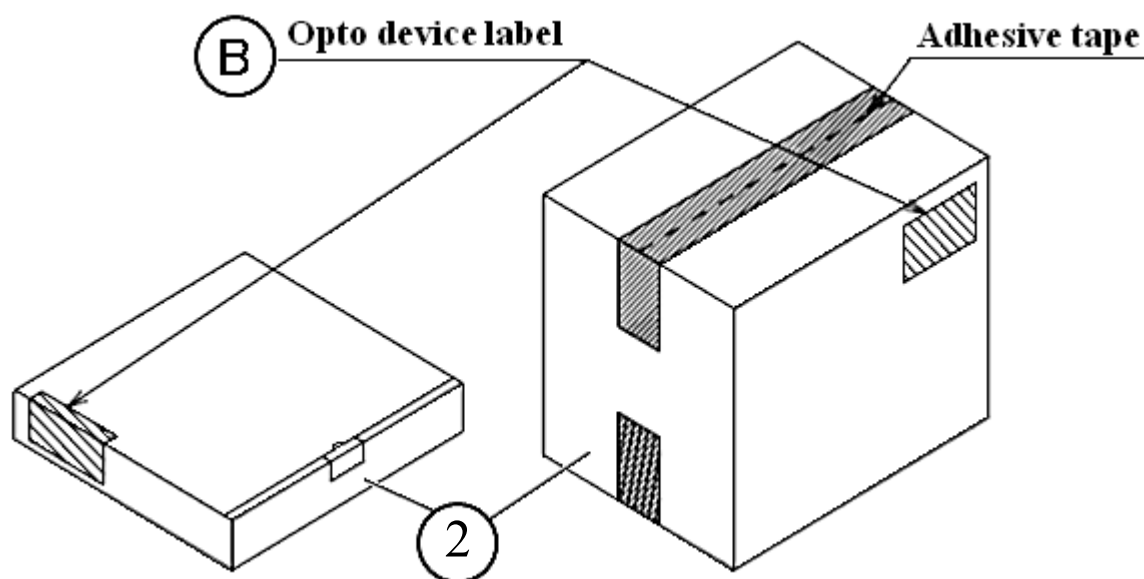
Type A

Material / Box : Cardboard

Type B, C

Material / Box : Cardboard , Partition : Cardboard

Type D

Material / Box : Cardboard

Type E, F

Material / Box : Cardboard

NO.	Part name	Material	Remarks
②	Packing box	Corrugated cardboard	without ESD protection

Packaging specifications

UGN1ZE140110-TR

【Label specification】

(acc.to ISO-IEC16388)

A Product label

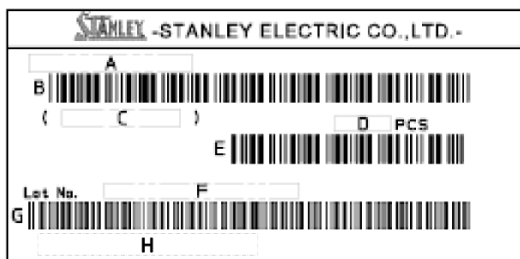

- A. Parts number
- B. Bar-code for parts number
- C. Parts code (In-house identification code for each parts number)
- D. Packed parts quantity
- E. Bar-code for packed parts quantity
- F. Lot number & rank
(refer to Lot number notational system for details)
- G. Bar-code for lot number & rank
- H. MSL

B Opto device label

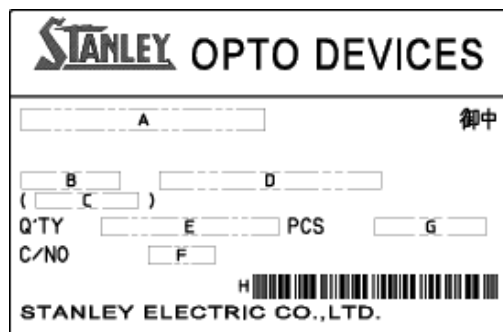

- A. Customer name
- B. Parts type
- C. Parts code
- D. Parts number
- E. Packed parts quantity
- F. Carton number
- G. Shipping date
- H. Bar-code for In-house identification number

<Remarks> Bar-code font : acc.to ISO-IEC16388

Taping and reel specifications

UGN1ZE140110-TR

【Appearance】

(acc.to IEC60286-3)

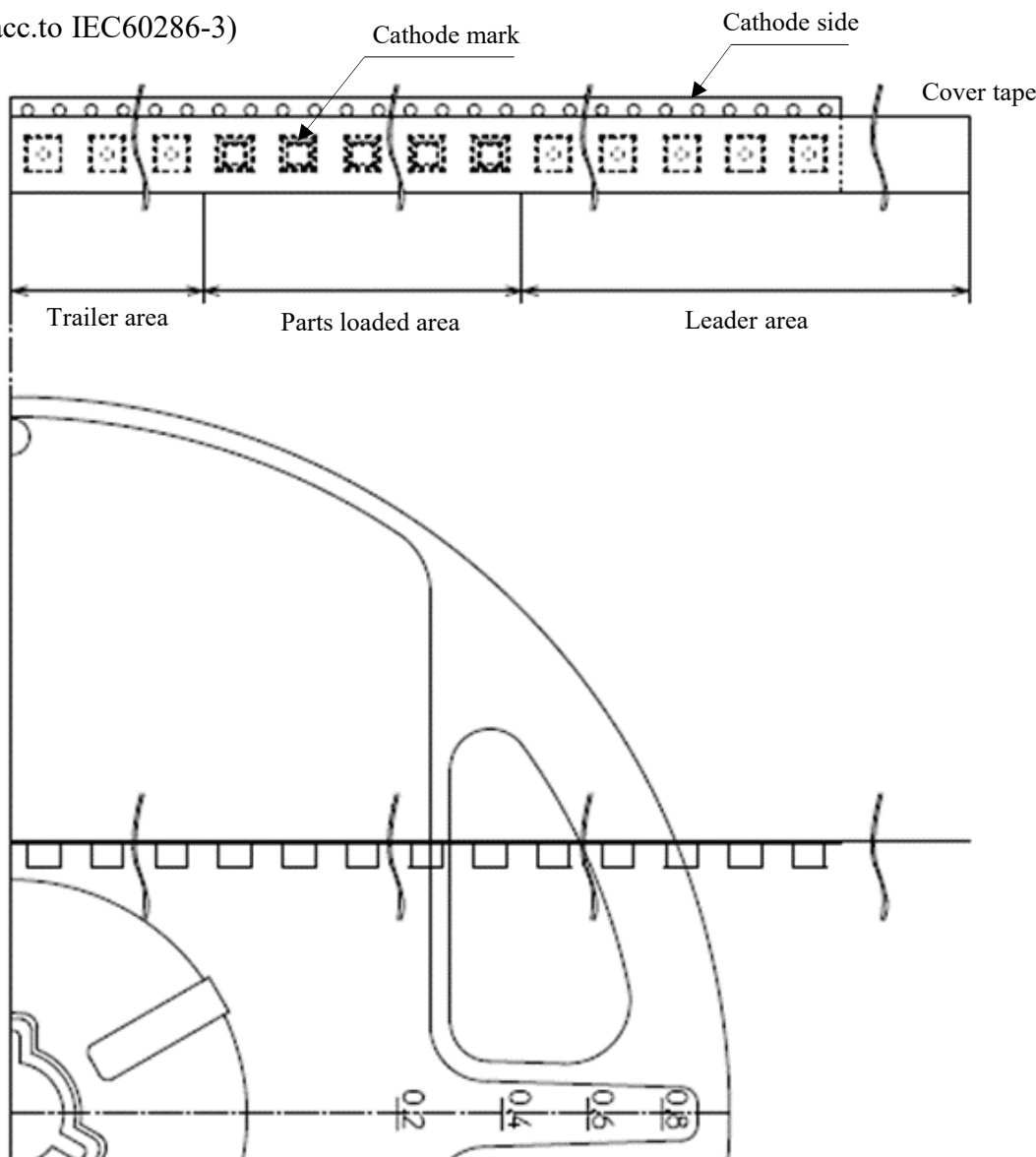

Note

"-TR" means Cathode Side of VCSEL should be placed on the sprocket-hole side.

Items		Specifications	Remarks
Leader area	Cover-tape	Cover-tape shall be longer than 300mm without carrier-tape.	The end of cover-tape shall be held with adhesive tape.
	Carrier-tape	Empty pocket shall be more than 13 pieces. (longer than 100mm)	Please refer to the above figure for Taping & reel orientation .
Trailer area		Empty pocket shall be more than 20 pieces. (longer than 160mm)	The end of taping shall be inserted into a slit of the hub.

Taping and reel specifications

UGN1ZE140110-TR

【Qty. per Reel】

1,000 parts/reel

Minimum Qty. per reel might be 100 parts when getting less than 1,000 parts. In such case, parts of 100-unit-qty. shall be packed in a reel and the qty. shall be identified on the label.

【Mechanical Strength】

Cover-tape adhesive strength shall be 0.1 to 1.3N (an angle between carrier-tape and cover-tape shall be 170 deg.) Both tapes shall be so sealed that the contained parts will not come out from the tape when it is bent at a radius of 15mm.

【Others】

Reversed-orientation, Up-side down placing, side placing and out of spec. parts mixing shall not be held. Empty pocket per reel is assumed until 1 piece.

Taping and reel specifications

UGN1ZE140110-TR

(acc.to IEC60286-3)

【Taping dimensions】

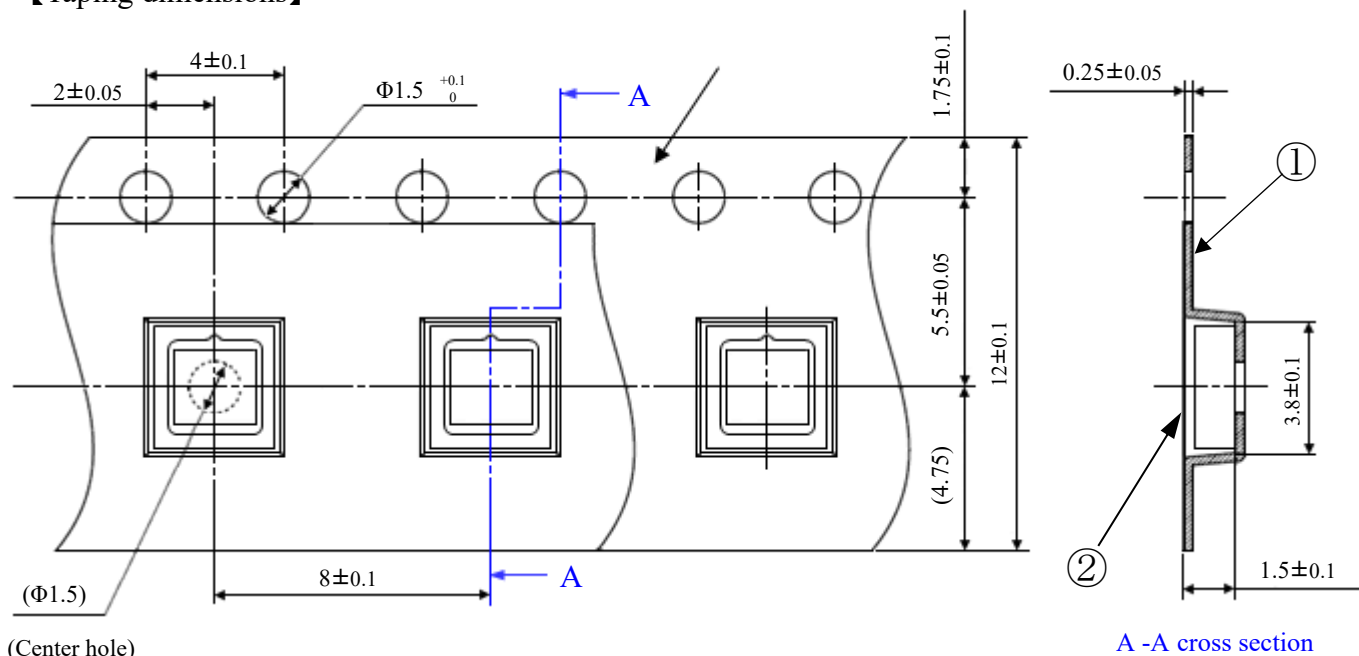

【Reel dimensions】

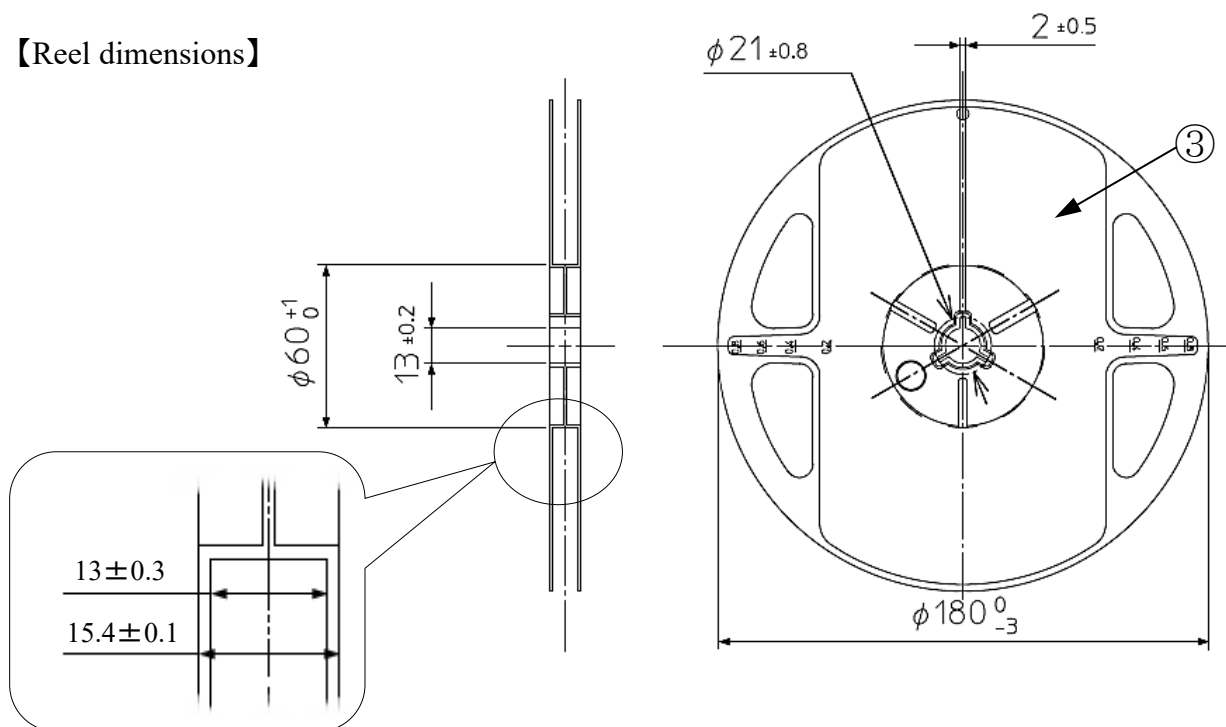

NO.	Part name	Remarks
①	Carrier tape	with ESD protection
②	Cover tape	with ESD protection
③	Carrier reel	with ESD protection

Lot number notational system

UGN1ZE140110-TR

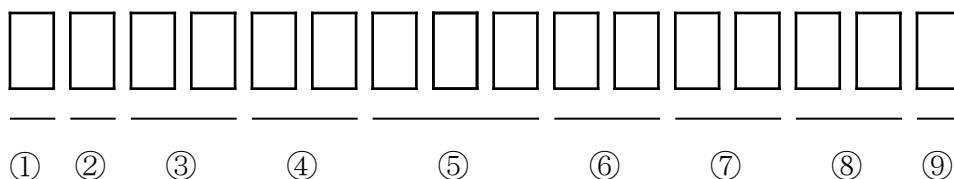

① - 1digit : Production location (mark identify alphabet)

② - 1digit : Production year (The last digit of production year 2025→5, 2026→6, 2027→7, 2028→8 …)

③ - 2digits : Production month (Jan. to Sep. , should be 01,02,03 …)

④ - 2digits : Production date

⑤ - 3digits : Serial number

⑥ - 2digits : Tape and reel following number

⑦ - 2digits : Total power rank.

(If total power rank is 1 digit, "-" shall be dashed on the place for the second digit.

If there is no identified rank, "- -" is used to indicate.)

⑧ - 2digits : Wavelength rank

(If wavelength rank is 1 digit, "-" shall be dashed on the place for the second digit.

If there is no identified rank, "- -" is used to indicate.)

⑨ - 1digit : VF Rank (If rank is not defined, "-" is described.)

Correspondence to RoHS / ELV instruction

UGN1ZE140110-TR

This product is in compliance with RoHS / ELV.

Prohibition substance and its criteria value of RoHS / ELV are as follows.

- RoHS instruction ... Refer to following 1 to 10.
- ELV instruction ... Refer to following 1 to 4.

2011/65/EU, (EU)2015/863

No.	Substance group name	Maximum permissible concentration value
1	Lead and its compounds	1,000ppm (0.1%)
2	Cadmium and its compounds	100ppm (0.01%)
3	Mercury and its compounds	1,000ppm (0.1%)
4	Hexavalent chromium compounds	1,000ppm (0.1%)
5	PBB : Polybrominated Biphenyls	1,000ppm (0.1%)
6	PBDE : Polybrominated Biphenyl Ethers	1,000ppm (0.1%)
7	DEHP : Bis (2-ethylhexyl) phthalate	1,000ppm (0.1%)
8	BBP : Butyl benzyl phthalate	1,000ppm (0.1%)
9	DBP : Dibutyl phthalate	1,000ppm (0.1%)
10	DIBP : Diisobutyl phthalate	1,000ppm (0.1%)

Reliability testing result

UGN1ZE140110-TR

1. Reliability testing result

No.	Test item	Test condition	Duration	Failure
1	High temperature operating life	Ta=85°C, Tj(VCSEL)=150°C, VR(PD)=5V	1,000h	0/18
2	Low temperature operating life	Ta=-40°C, IF(VCSEL)=2A, VR(PD)=5V	1,000h	0/18
3	High temperature humidity bias operating life 1	Ta=85°C, 85%RH, Tj(VCSEL)=150°C, VR(PD)=5V	1,000h	0/18
4	Pulse operating life	Ta=85°C, tw=100μs, 1% duty, IF(VCSEL)=7A, VR(PD)=5V	1,000h	0/18
5	Gas exposure test	H2S 15ppm, Ta=40°C, 90% Rh	96h	0/18
6	Thermal shock	Ta=-40°C(15min) to 125°C (15min)	1,000cycles	0/18
7	Resistance to reflow soldering	Moisture soak : Jedec Level 3 Preheating : 150 to 180°C 120sec Max. Soldering : 260°C 5sec	2times	0/18
8	Thermal & high temperature cycle	Ta=-30°C to 80°C, 90%RH, Tj(VCSEL)=150°C(When lit up at Ta=80°C) (5min ON - 5min OFF)	1,000cycles	0/18
9	Electric static discharge (HBM)	C=100pF, R2=1.5kΩ, ±2kV	3times each polarity	0/18
10	Electric static discharge (CDM)	±1kV	3times each polarity	0/18
11	Vibration test	20G Max. (Acceleration) or 1.52mm (Displacement) 20 to 2,000 to 20Hz (4min.)	4 cycle each X, Y and Z axis	0/18
12	Mechanical shock	1,500G, 0.5ms	5 times each 6 direction	0/18

2. Failure criteria

Item		Symbol	Acceptance criteria
VCSEL	Total radiant flux	Φ_e	Measured value > initial value × 1.2, measured value < initial value × 0.8
	Forward voltage	V_F	Measured value > initial value × 1.1, measured value < initial value × 0.9
	Reverse current	I_R	Measured value \geq Specification value × 2.5
PD	Dark current	I_d	Measured value \geq Specification value × 2.5
VCSEL + PD (Coupling characteristics)	Photo current	I_p	Measured value > initial value × 1.2, measured value < initial value × 0.8
Appearance		—	Notable discoloration, deformation or cracks

Special notice to customers using the products and technical information shown in this data sheet

- 1) The technical information shown in the data sheets are limited to the typical characteristics and circuit examples of the referenced products. It does not constitute the warranting of industrial property nor the granting of any license.
- 2) For the purpose of product improvement, the specifications, characteristics and technical data described in the data sheets are subject to change without prior notice. Therefore it is recommended that the most updated specifications be used in your design.
- 3) When using the products described in the data sheets, please adhere to the maximum ratings for operating voltage, heat dissipation characteristics, and other precautions for use. We are not responsible for any damage which may occur if these specifications are exceeded.
- 4) The products that have been described to this catalog are manufactured so that they will be used for the electrical instrument of the benchmark (OA equipment, telecommunications equipment, AV machine, home appliance and measuring instrument).
The application of aircrafts, space borne application, medical equipment and nuclear power control equipment, etc. needs a high reliability and safety, and the breakdown and the wrong operation might influence the life or the human body. Please consult us beforehand if you plan to use our product for the usages of aircrafts, space borne application, transportation equipment, medical equipment and nuclear power control equipment, etc. except OA equipment, telecommunications equipment, AV machine, home appliance and measuring instrument.
- 5) In order to export the products or technologies described in this data sheet which are under the “Foreign Exchange and Foreign Trade Control Law,” it is necessary to first obtain an export permit from the Japanese government.
- 6) No part of this data sheet may be reprinted or reproduced without prior written permission from Stanley Electric Co., Ltd.
- 7) The most updated edition of this data sheet can be obtained from the address below:
en <https://www.stanley-electric.com/en/products/>
cn <https://www.stanley-electric.cn/cn/products/>



WARNING

- This product **emits strong laser light (infrared) when it is lit up.**
- **Do not look directly into the light source, for it could damage your eyes.**
- **Should it be necessary to observe the product while it is being lit, always use protective glasses that block infrared laser light.**
- **Please also take sufficient safety measures against light leakage, etc., in order to avoid any influence on the human body.**