

LED FLOODLIGHT

LLF0112A Middle type Installation Instructions

For retention

● This product must be installed in accordance with applicable national and local electrical and construction codes by a qualified electrician. Installation by an unqualified person is prohibited by law.

Name (※1)	1/2 beam angle	Light Color	Color Rendering Index (※2)	Control system (※3)	Standard (※4)	Body Color (※5)
LLF0112A/MWWD02822◇10S△△□C○○1*	10°	2200K	Ra70	ON-OFF 0-10V dimming DALI dimming DMX dimming	PSE TIS	Charcoal gray White Silver
LLF0112A/MWWD02822◇20S△△□C○○1*	20°					
LLF0112A/MWWD02822◇30S△△□C○○1*	30°					
LLF0112A/MWWD02822◇50S△△□C○○1*	50°					
LLF0112A/MWWD02827◇10S△△□C○○1*	10°	2700K				
LLF0112A/MWWD02827◇20S△△□C○○1*	20°					
LLF0112A/MWWD02827◇30S△△□C○○1*	30°					
LLF0112A/MWWD02827◇50S△△□C○○1*	50°					
LLF0112A/MWWD02830◇10S△△□C○○1*	10°	3000K				
LLF0112A/MWWD02830◇20S△△□C○○1*	20°					
LLF0112A/MWWD02830◇30S△△□C○○1*	30°					
LLF0112A/MWWD02830◇50S△△□C○○1*	50°					
LLF0112A/MWWD02840◇10S△△□C○○1*	10°	4000K				
LLF0112A/MWWD02840◇20S△△□C○○1*	20°					
LLF0112A/MWWD02840◇30S△△□C○○1*	30°					
LLF0112A/MWWD02840◇50S△△□C○○1*	50°					
LLF0112A/MWWD02850◇10S△△□C○○1*	10°	5000K				
LLF0112A/MWWD02850◇20S△△□C○○1*	20°					
LLF0112A/MWWD02850◇30S△△□C○○1*	30°					
LLF0112A/MWWD02850◇50S△△□C○○1*	50°					
LLF0112A/MWWD02857◇10S△△□C○○1*	10°	5700K				
LLF0112A/MWWD02857◇20S△△□C○○1*	20°					
LLF0112A/MWWD02857◇30S△△□C○○1*	30°					
LLF0112A/MWWD02857◇50S△△□C○○1*	50°					
LLF0112A/MWWD02865◇10S△△□C○○1*	10°	6500K				
LLF0112A/MWWD02865◇20S△△□C○○1*	20°					
LLF0112A/MWWD02865◇30S△△□C○○1*	30°					
LLF0112A/MWWD02865◇50S△△□C○○1*	50°					
LLF0112A/MWWD028YEN10S△△□C○○1*	10°	GOLD	-			
LLF0112A/MWWD028YEN20S△△□C○○1*	20°					
LLF0112A/MWWD028YEN30S△△□C○○1*	30°					
LLF0112A/MWWD028YEN50S△△□C○○1*	50°					

※1 ◇□△* in the name will be the following character string depending on the product specifications.

◇... Color Rendering Index (※2)
Ra70 : X None : N

□... Control system (※3)
ON/OFF : S

0-10V dimming (Curve:Log) : B 0-10V dimming (Curve:Linear) : E
DALI dimming (Curve:Log) : C DALI dimming (Curve:Linear) : F
DMX dimming (Curve:Log) : D DMX dimming (Curve:Linear) : G

○○...Standard (※4)
Apply to CE, CE/PSE : CE
Apply to PSE : PS
Apply to TIS : TS

△△... Body Color (※5)
Charcoal gray : BK White : WH Silver :SI

* ...Described in the case of custom specifications.

- This product is classified as Class I luminaire.
- The classification of insulation of the dimmable models between dimming circuit and LV supply (AC input) is basic insulation.
- This product is heavy-duty salt resistant spec.
- The product is not protected against lightning surge. Please purchase a SPD (Lightning Surge Protection Device) as necessary.
- When the external flexible cable or cord of this luminaire is damaged, it shall be replaced only by the manufacturer or its service agent or a similar qualified person in order to avoid a hazard.
- The light source of this luminaire is not replaceable; when the light source reaches its end of life, the whole luminaire shall be replaced.
- Terminal block not included. Installation must be performed by a qualified person.
- Install the luminaires without looking at them for long periods of time.
- The luminaire should be positioned so that prolonged staring into the luminaire at a distance closer than 15 m is not expected.
- LED has dispersion in brightness and light color. The product may have different light color and brightness even among products with the same model number.
- Please note that unevenness of the projected light may be noticeable depending on the irradiation distance or the condition of the irradiation surface.
- This product contains a light source of energy efficiency class <E> based on (EU)2019/2015.

• The name of the light source installed in products with color temperatures of 2200K to 6500K are as follows.

CT	Name of the light source	Energy efficiency class based on (EU)2019/2015
2200K	LLM0112A/P-SAY 22X 5-16374A	NA
2700K	LLM0112A/P-SAY 27X 5-16374A	<E>
3000K	LLM0112A/P-SAY 30X 5-16374A	<E>
4000K	LLM0112A/P-SAY 40X 5-16374A	<E>
5000K	LLM0112A/P-SAY 50X 5-16374A	<E>
5700K	LLM0112A/P-SAY 57X 5-16374A	<E>
6500K	LLM0112A/P-SAY 65X 5-16374A	<E>

● Product Summary

SPEC	ON-OFF	DALI調光	DMX調光	0-10V調光
Input Voltage	AC100~240V			
Input Current	0.31~0.14A	0.29~0.13A	0.30~0.13A	
Power Consumption	28.3W(100V) 27.9W(240V)	28.7W(100V) 29.1W(240V)	29.8W(100V) 30.1W(240V)	
IP Rating	IP66			
Operating Temperature Range	- 25~50°C			
Mass	4.2kg	4.3kg		
Dimension	W246 H295 D122			
Projected Area	0.046m ²			

Construction Leave the instructions for users/customers for future reference.

 WARNING	Failure to comply with the following installation instructions may result in death or serious injury.
<ul style="list-style-type: none"> • This product must be installed in accordance with the installation instructions to avoid malfunction, fixture fall, electrical shock or fire. • Do not use the product in the following environment or situation. It may cause fall of the fixture, electric shock or fire. <ul style="list-style-type: none"> - Places where the humidity exceeds 90% RH or the product is covered with water. - Places where vibration or shock are transmitted to the fixture, e.g. where the crane is installed. - Places where fixtures are directly exposed to organic solvents (acetone, ethyl ether, hexane, etc.) - Places filled with corrosive gas (hydrogen sulfide, ammonia, etc.) and flammable gas (hydrogen, methane, propane, etc.) - Indoor pools where chlorine is used. - Places where flammable liquid (gasoline, kerosene, heavy oil, etc.) is used. - Places where there is much oil mist, e.g. metal working plants, kitchens, etc. - Place with much mine dust. - Places covered with heat insulating materials or combustibles. - Places where fixtures are buried in snow. • Do not disassemble or modify the fixture. It may cause fall of the fixture, electric shock or fire. • Do not remove the vent filter and give shock to the fixture to avoid water intrusion. • Use a waterproof junction box for connection to the power cable. • Do not operate the product when it is damaged. It may cause fall of the fixture, electric shock or fire. • If there are abnormalities found in the product such as smoke or unusual odor, disconnect power immediately and contact dealers. • Use the fixture within the specified input voltage range. • Please perform class D grounding work(100 ohms and below) for the ground wire. Failure to perform grounding work may cause a fire or electric shock. 	

 CAUTION	Failure to comply with the following installation instructions may result in injury or property damage.
<ul style="list-style-type: none"> • This product is only for general outdoor or general indoor use. It cannot be used anywhere else. It may cause a fall, electric shock, or fire. • A high brightness LED is used as a light source. Do not look directly at the light source (LED). • The wind pressure resistance is 60m / s. Do not install in places where the wind speed exceeds it to avoid fall of the fixture. • The product must be used with the specified input voltage and frequency. • Use the fixture within the specified operating temperature. During the daytime, do not use it except for temporary operation check. Failure to comply with them may reduce the life of the fixture and cause electrical shock or fire. • When the product is used in cold areas, do not install in places where icicles can fall. • Do not install the product in places containing sulfur component such as hot spring. • Do not install the product towards the sun. Concentrated sunlight may damage the LED and result in malfunction or fire. • Do not use without the shade and secondary lens attached. Condensation may form inside. • Do not install the light source of this product in a place where people can keep looking at it for a long time. • Do not intentionally touch or remove the vent filter or cable gland. It may impair waterproofness. • Observe the following installing conditions when installing this product. 	

PARTS

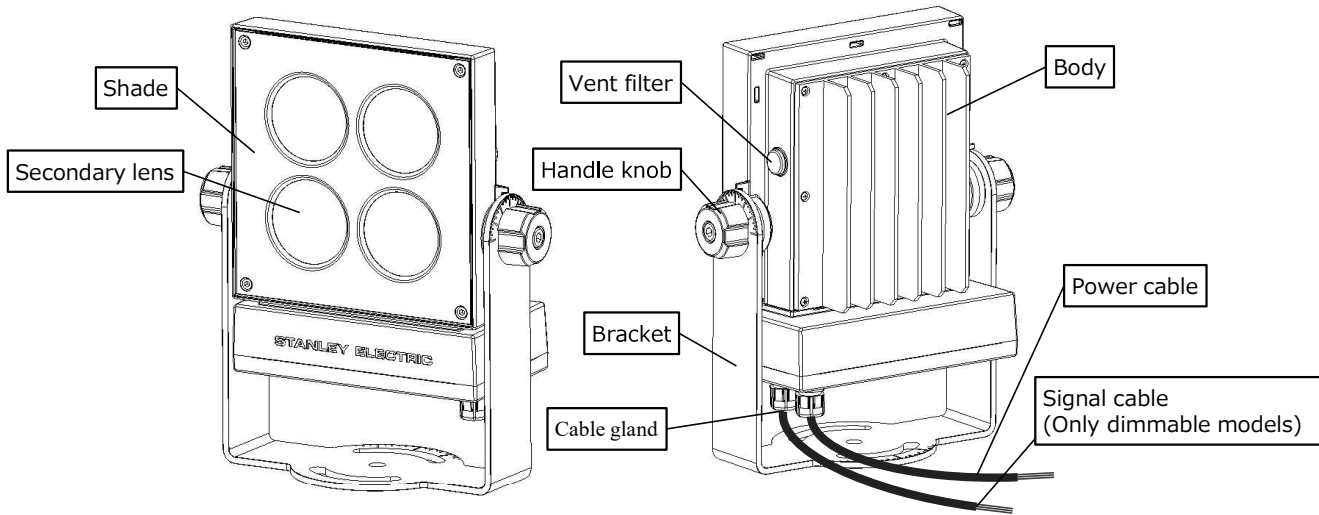

INSTALLATION

1. Install two M10 anchor bolts in the ground.

2. Secure the bracket to the anchor bolts using plain washers, spring lock washers and hexagon nuts.

Recommended torque : 24,5 N·m

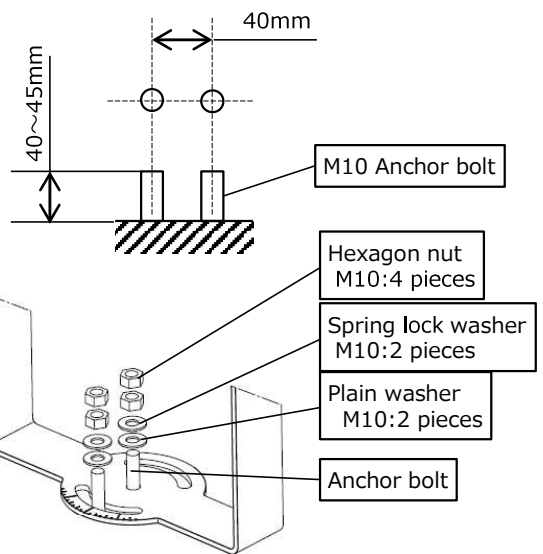

※When I attach an appliance,
all aspects of the base of the bracket,
please contact with a setting side.

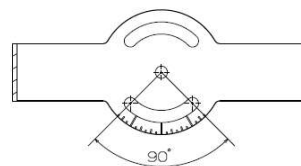

Bracket rotation range

Installing conditions

1. This product can be installed in all directions. When it is installed outside, Make sure vent filter and cable gland are not exposure directly rain. There is in danger of breaking.

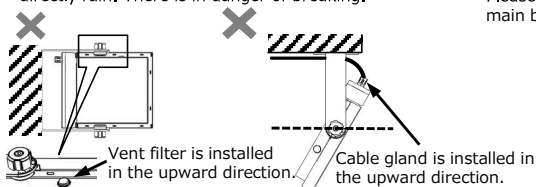

2. When you bent the lead cables near the main body, water may get in from the gap between lead cables and cable gland and there is in danger of breaking. Please make sure install with extra length from the main body.

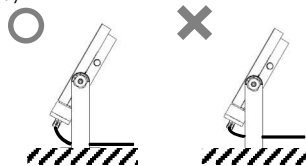

3. Within $\pm 5^\circ$ from the horizontal, when using the body with the irradiation surface facing upwards, water may accumulate inside the secondary lens and affect the light distribution performance.

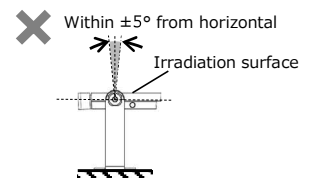

Electrical installation

1. Before installing, disconnect power to avoid electrical shock.
2. Connect the lead wire to the power cable and signal cable.
Use waterproof junction boxes to avoid water entry, electrical shock and fire.
When connecting the wire to the junction box, put the cable of the wire inside the box.

● ON-OFF models wiring diagram

	Sheath outer diameter	Conductor size	Wire color	Polarity
Power Cable	Φ7.7	1.0 sq	Brown	AC/L
			Blue	AC/N
			Green / Yellow	E

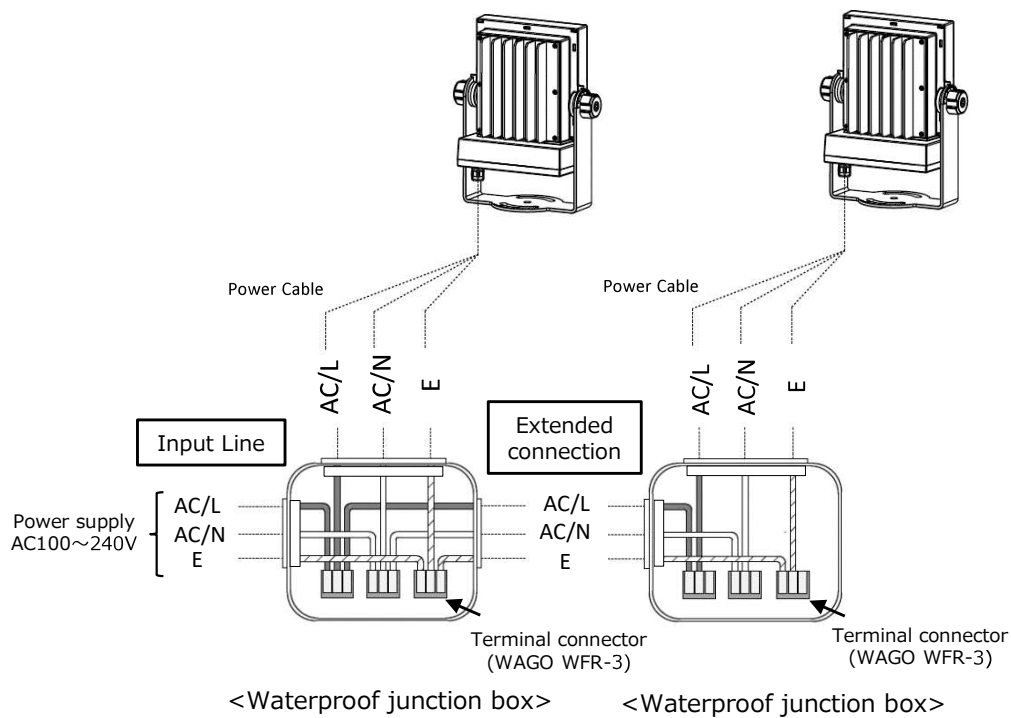

Electrical installation

- 0-10V dimming models Connection and connection
 - controller required for floodlight. Without the controller, it can malfunction.

< Example >

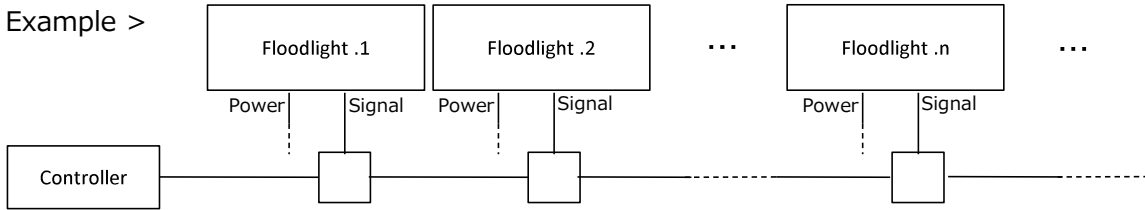

- 0-10V dimming models wiring diagram

	Sheath outer diameter	Conductor size	Wire color	Polarity
Power Cable	Φ7.7	1.0 sq	Brown	AC/L
			Blue	AC/N
			Green/Yellow	E
Signal Cable 0-10V	Φ7.7	1.0 sq	Brown	0-10V +
			Blue	0-10V -

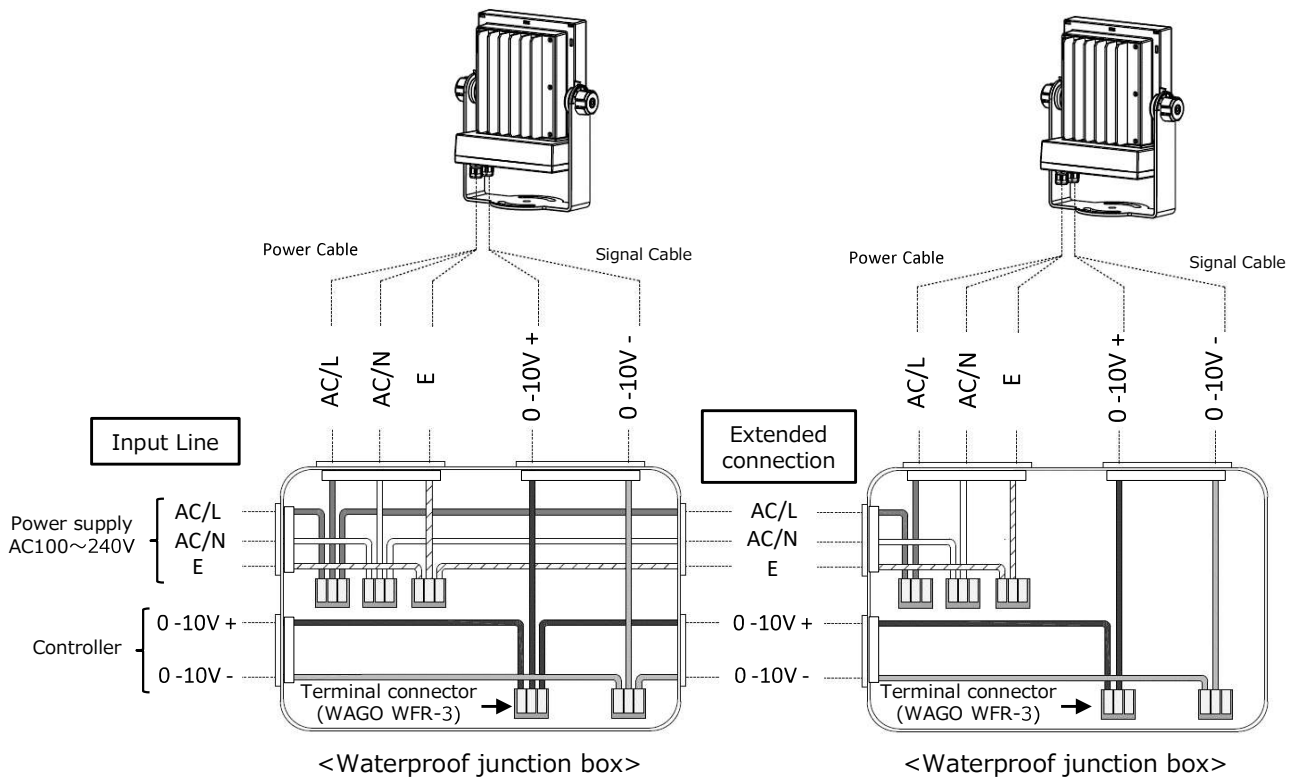

Electrical installation

● DALI dimming models Connection and connection

- DALI controller required for floodlight. Without the DALI controller, it can malfunction.
- When connecting floodlights, the upper limit is 64 units per signal line.

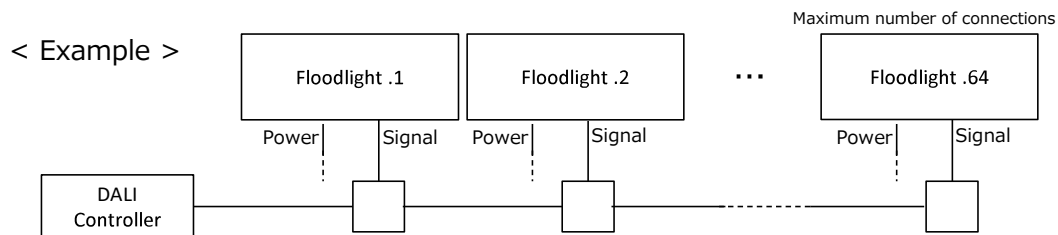

● DALI dimming models wiring diagram

	Sheath outer diameter	Conductor size	Wire color	Polarity
Power Cable	Φ7.7	1.0 sq	Brown	AC/L
			Blue	AC/N
			Green/Yellow	E
Signal Cable DALI	Φ7.7	1.0 sq	Brown	Data +
			Blue	Data -

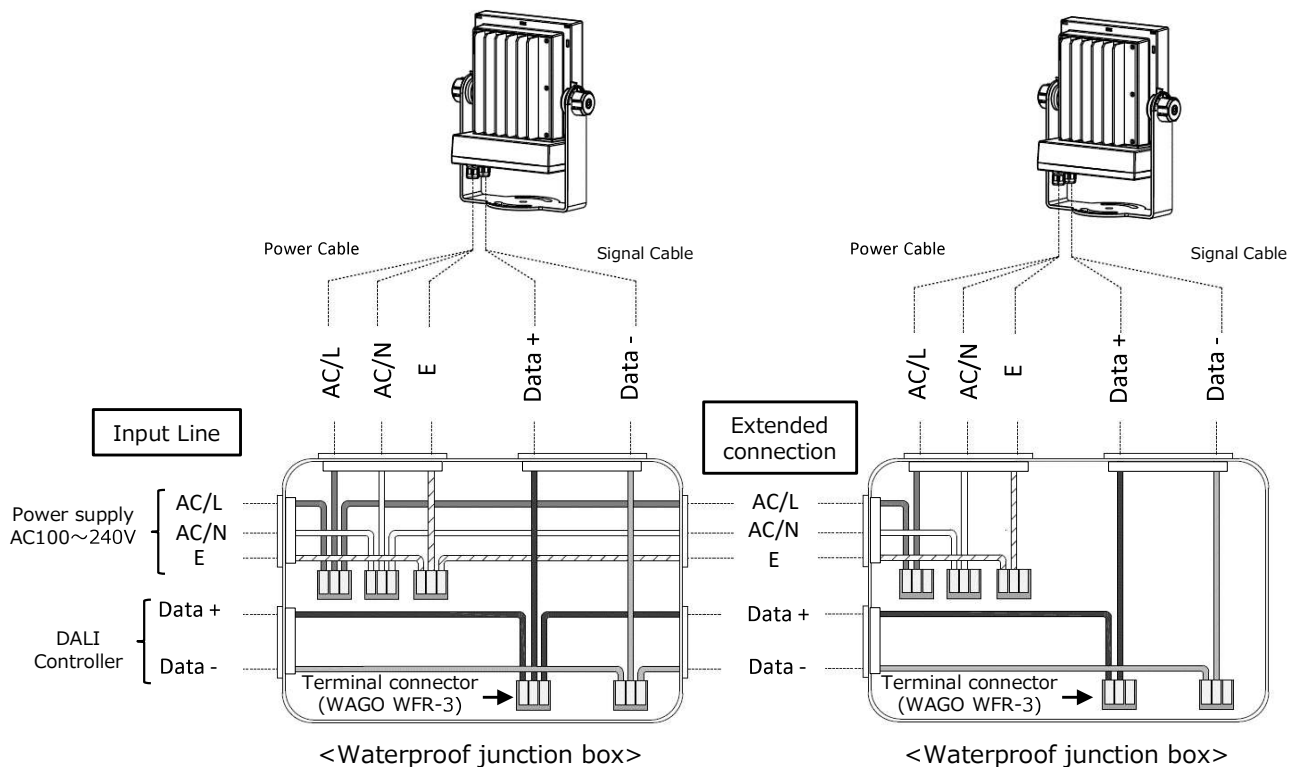

Electrical installation

DMX dimming models Connection and connection

- DMX controller required for floodlight. Without the DMX controller, it can malfunction.
- When connecting floodlights, the upper limit is 32 units per signal line. When connecting 33 or more units to one dimming line, use a signal amplifier such as a repeater.
- Be sure to connect this product with a terminator (a terminating resistor) to the end of the dimming line.

< Example >

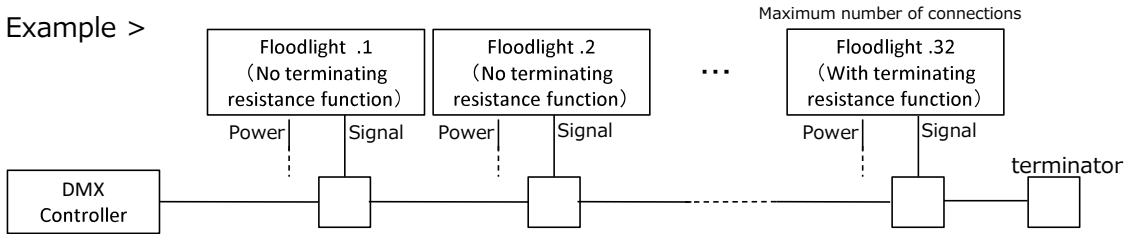

DMX dimming models wiring diagram

※1 Signal Cable diagram

	Sheath outer diameter	Conductor size	Wire color	Polarity
Power Cable	Φ7.7	1.0 sq	Brown	AC/L
			Blue	AC/N
			Green / Yellow	E
Signal Cable (DMX) ※1	Φ9.5	0.5 sq	White	Data +
			Blue	Data -
			White	Not used
		Yellow	Not used	
		0.2 sq	Drain wire ※2	SG

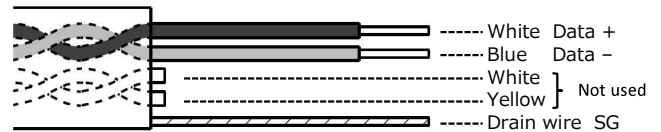
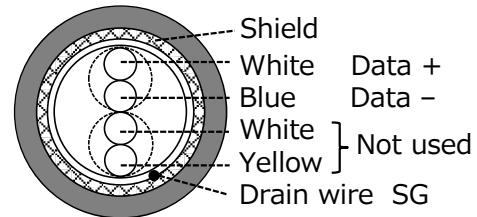

※2 Please insulate when wiring.

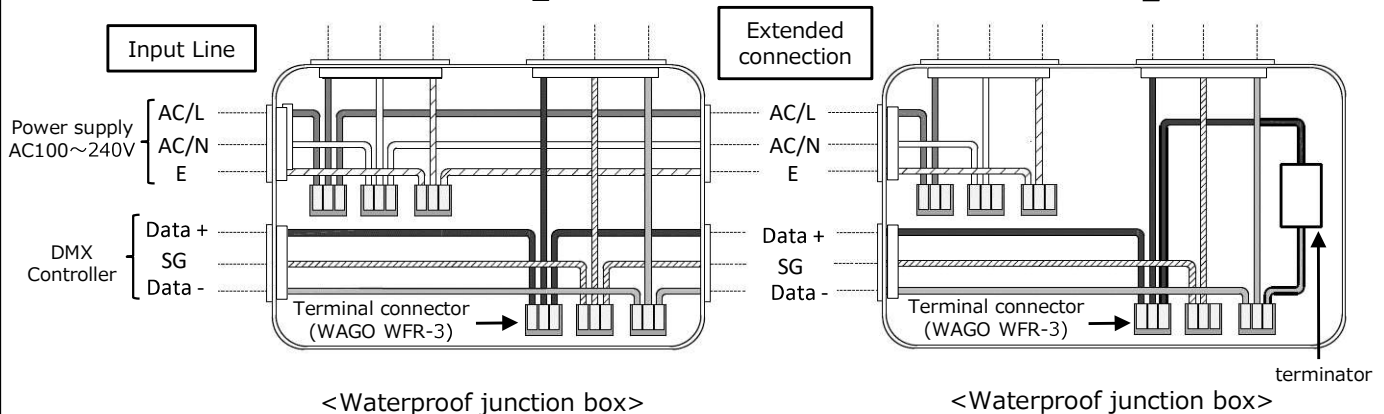
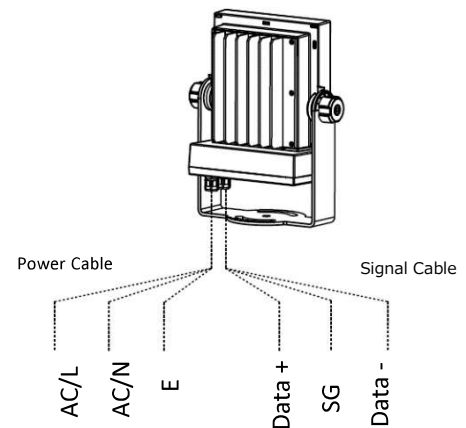
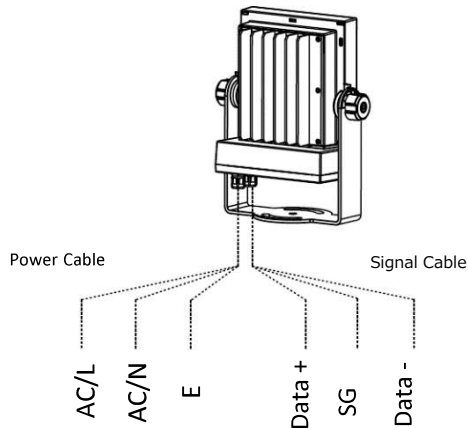

Adjustable beam orientation

• Loosen the right and left screws with the handle knobs, and then tilt the fixture while supporting it by hand.

• Re-tighten the screws with the handle knobs. Ensure that the hexagon socket head bolts are tightened by a proper tool.

Recommended

torque : 20 N·m

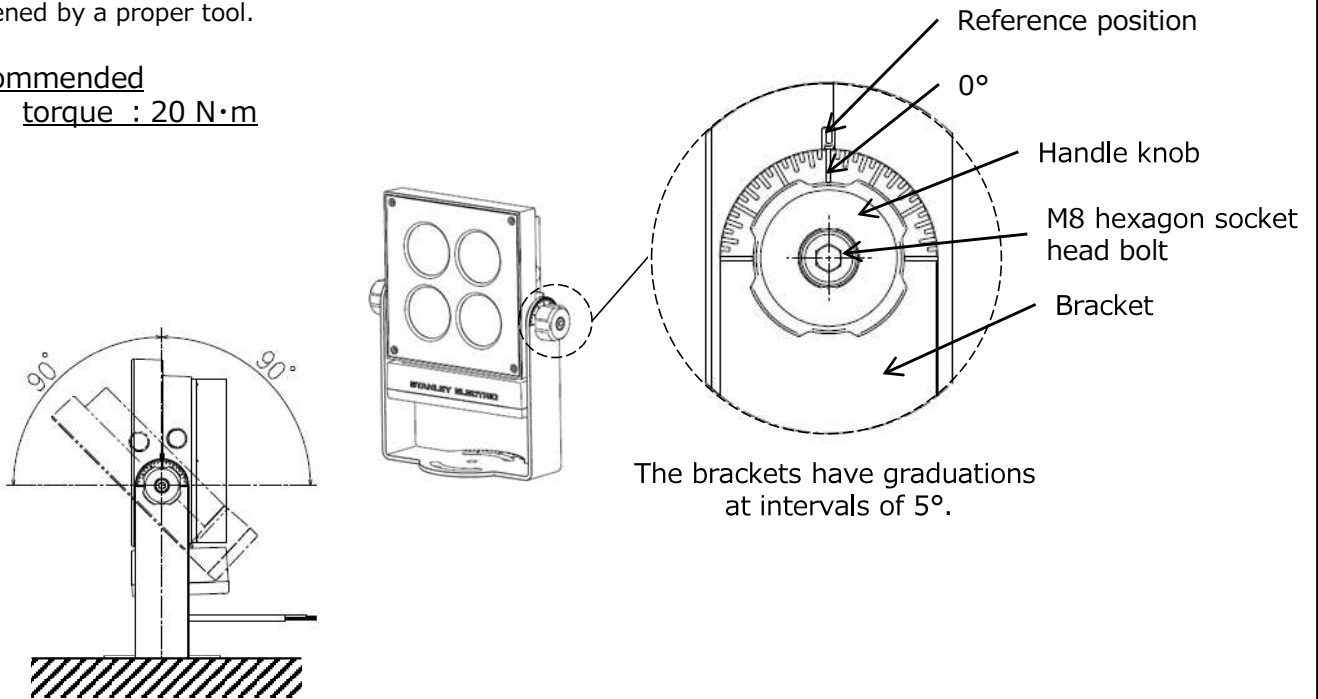

Adjustable vertical pivot limit

Fall prevention wire

When installing the product in high places, attach the fall prevention wire (sold separately) to the strong construction material as shown below.

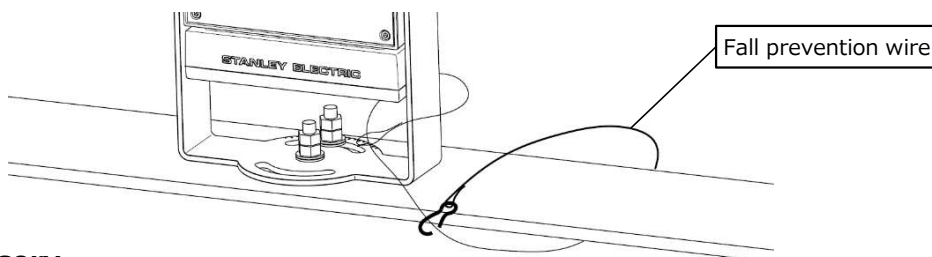

Accessory

When attaching accessories (sold separately) to the product, refer to each instruction manual.

**WARNING**

Failure to comply with the following installation instructions may result in death or serious injury.

- This product must be cleaned in accordance with the installation instructions to avoid fall of fixture, electrical shock or fire.
- Turn off the power before cleaning the product.
- Do not repair, disassemble, or modify the fixture.

**CAUTION**

Failure to comply with the following installation instructions may result in injury or property damage.

- A high brightness LED is used as a light source. Do not look directly at the light source (LED).
- Turn off the power and leave the fixture until it becomes ordinary temperature before cleaning to avoid a burn.
- High ambient temperature can reduce the product life.
- If there are abnormalities found in the product within the lifetime, disconnect the power immediately and contact your dealer. Using the product with abnormalities may cause fire or electrical shock.
- When the product is used in a snowy area, remove the snow to prevent the product from being buried in snow.
- Dirt on the fixture can reduce efficiency. It is recommended to clean the fixture by yourself once a year.
- Conduct self-inspection at least once a year for safety.
- Have the product inspected by experts at least once every three years. (A product used for more than three years requires a thorough inspection.) Using the product with abnormalities may cause smoking, fire, electric shock or fall of the fixture.
- LED has dispersion in brightness and light color. The product may have different light color and brightness even among products with the same model number.
- Please note that unevenness of the projected light may be noticeable depending on the irradiation distance or the condition of the irradiation surface.
- Keep radios, TV or equipment with infrared remote-control systems away from the fixture.
- Do not install in places where the product will undergo sudden cooling or heating, which may cause condensation inside the product.
- Do not modify or add parts to make water gather around the vent filter.
- Do not intentionally touch or remove the vent filter or cable gland. It may impair waterproofness.

Cleaning

- Turn off the power and leave the fixture until it becomes ordinary temperature before cleaning to avoid a burn.
- Clean the outer surface of the fixture or the cover with a soft cloth wetted with water or neutral detergent.
- Do not use volatile substances (e.g. thinner and benzine) or acid-alkaline detergent. Using such substances may cause discoloration or deformation.
- Do not spray water directly on the fixture with tools like a hose. Moreover, do not clean the fixture with a mop, a deck brush. They may cause water intrusion or damage to the fixture.

Warranty

- Immediately after delivery, conduct an acceptance inspection and judge whether it is acceptable or unacceptable. If no special problems are raised, we will judge that quality confirmation has been conducted and the acceptance inspection has been passed.
- Check the warranty period described on the warranty card. The warranty covers each single article delivered. It does not cover costs such as work fees and damage compensation incurred because of replacement work.
- The warranty does not cover failure caused by the following:
 - (1) Inadvertent handling and misuse
 - (2) Remodeling or repair by yourself
 - (3) Use under improper environment and conditions
 - (4) Natural disasters (fire, earthquake, and typhoon)
 - (5) Water condensation that occurs when the product is used out of the use and preservation temperature conditions specified in the specification sheet
 - (6) Electrical stress, such as excessive voltage surge, including lightning
- If the cause of the failure cannot be identified, negotiations shall be conducted between the two companies.
- The application of this product is intended as a lighting or light source. We shall not assume any responsibility for any damage caused by use under an application not intended by us.

Exchange

- During the warranty period, contact the retailer (construction shop) where you purchased the product with an item that can specify the delivery date.
- If the warranty period has expired, consult your dealer (construction shop).
We will exchange it for a fee on request.
- If you have any questions about after-sales service or consult about replacement, please contact the retailer where you purchased the product (construction shop) or our sales office below. In that case, please let us know the product name and the time of purchase.

Contact

- Please contact us after confirming the product name on the nameplate.
- Phone number and address may change. Please confirm the website.

STANLEY ELECTRIC CO.,LTD.

Yokohama Technical Center: 2-14-1 Edanishi, Aoba-ku, Yokohama-shi, Kanagawa, 225-0014 Japan

TEL : +81 45 910 6629

URL: <http://www.stanley.co.jp/>

Headquarters: Nakameguro, Meguro-ku, Tokyo, 153-8636 Japan

TEL :+81 3 3710 2222